

 Ontario**Book 11****Ontario  
Traffic  
Manual****March 2000**

# **Pavement, Hazard and Delineation Markings**

# Ontario Traffic Manual

## Foreword

The purpose of the Ontario Traffic Manual (OTM) is to provide information and guidance for transportation practitioners and to promote uniformity of treatment in the design, application and operation of traffic control devices and systems across Ontario. The objective is safe driving behaviour, achieved by a predictable roadway environment through the consistent, appropriate application of traffic control devices. Further purposes of the OTM are to provide a set of guidelines consistent with the intent of the Highway Traffic Act and to provide a basis for road authorities to generate or update their own guidelines and standards.

The OTM is made up of a number of Books, which are being generated over a period of time, and for which a process of continuous updating is planned. Through the updating process, it is proposed that the OTM will become more comprehensive and representative by including many traffic control devices and applications specific to municipal use. Some of the Books of the OTM are new, while others incorporate updated material from the Ontario Manual of Uniform Traffic Control Devices (MUTCD) and the King's Highway Guide Signing Policy Manual (KHGSPM).

The Ontario Traffic Manual is directed to its primary users, traffic practitioners. The OTM incorporates current best practices in the Province of Ontario. The interpretations, recommendations and guidelines in the Ontario Traffic Manual are intended to provide an understanding of traffic operations and they cover a broad range of traffic situations encountered in practice. They are based on many factors which may determine the specific design and operational effectiveness of traffic control systems. However, no manual can cover all contingencies or all cases encountered in the field. Therefore, field experience and knowledge of application are essential in deciding what to do in the absence of specific direction from the Manual itself and in overriding any recommendations in this Manual.

The traffic practitioner's fundamental responsibility is to exercise engineering judgement and experience on technical matters in the best interests of the public and workers. Guidelines are provided in the OTM to assist in making those judgements, but they should not be used as a substitute for judgement.

Design, application and operational guidelines and procedures should be used with judicious care and proper consideration of the prevailing circumstances. In some designs, applications, or operational features, the traffic practitioner's judgement is to meet or exceed a guideline while in others a guideline might not be met for sound reasons, such as space availability, yet still produce a design or operation which may be judged to be safe. Every effort should be made to stay as close to the guidelines as possible in situations like these, and to document reasons for departures from them.

## Acknowledgements

The production of this Ontario Traffic Manual Book 11 (Markings and Delineation) was made possible as a result of the generous contributions of several individuals and organizations. It is important to recognize the contributions of the following individuals:

### Ministry of Transportation Project Advisory Committee Members

Greg Junnor – Project Manager, Traffic Program Management Office, Innovative Solutions Team

Harold Doyle, Traffic Program Management Office, Signs and Markings

Dave Edwards, Traffic Program Management Office, Innovative Solutions Team

Tom Fletcher, Traffic Program Management Office Manager

Al Atchison, Head, Southwest Region Traffic

Ted Keen, Maintenance Operations & Equipment Engineering

Soren Pedersen, Surveys and Design

Aatur Bacchus, Research and Development

### Technical Advisory Committee Members

Dave Aspinwal, (York Region) Municipal Engineers Association (MEA)

Blair Anderson, (Municipality of Chatham/Kent) Ontario Traffic Conference (OTC)

Bill Obee, Ontario Good Roads Association (OGRA)

John Vording, Ontario Good Roads Association (OGRA)

Gerry Forbes, (Regional Hamilton-Wentworth) Regional Municipality

Bob Butrym, (Town of Halton Hills) Rural Municipality

Dr. Bhagwant Persaud, (Academics) Ryerson University

Craig White, (Private Sector) Canadian Highways International Corporation

Myles Currie, (City of Toronto) Urban Municipality

### Quality Control Advisors

Dr. Frank Navin, University of British Columbia

Dr. Richard van der Horst, TNO Human Factors Research Institute

### Consultant Team Members

John McGill – Project Manager, Synectics Transportation Consultants

Bruce Cane, Synectics Transportation Consultants

Amy Ibrahim, Synectics Transportation Consultants

Kris Jacobson, Synectics Transportation Consultants

Sany Zein, Synectics Transportation Consultants

Sarah Rocchi, Synectics Transportation Consultants

Patrick Cook, TAP Training

Anne Pobst, TAP Training

Rod Edwards, Harpar Management Corporation

Alison Smiley, Human Factors North

Gerson Alexander, Positive Guidance Applications

Suzanne Dujoy, Graphic Design Consultant

The project team would like to acknowledge the staff of 3M, Traffic Control, Materials Division, whose contribution to the development of the new sections on engineering theory and practice was most meaningful. A special thanks for arranging this contribution belongs to Mr. Bob Margisson and Mr. Peter Trowhill of 3M Canada.

# Table of Contents

<b>1.</b>	<b>Introduction</b> .....	<b>11</b>
1.1	Purpose, Scope and Contents .....	11
1.2	Legal Authority .....	13
1.3	Standardization .....	13
<b>2.</b>	<b>General Principles</b> .....	<b>14</b>
2.1	Functions of Markings and Delineation .....	14
2.2	Limitations .....	14
2.3	Delineation and Driver Requirements .....	14
	Contrast .....	15
	Illumination .....	15
	Retroreflectivity .....	15
	Driver Factors .....	16
2.4	Colours .....	16
2.5	Materials .....	16
2.6	Application .....	18
2.7	Temporary Conditions .....	18
2.8	Removal .....	19
2.9	Maintenance .....	19
	Retroreflectometers .....	20
<b>3.</b>	<b>Pavement Markings</b> .....	<b>21</b>
3.1	General .....	21
	Types .....	21
	Function .....	21
	Limitations .....	22
	Colours .....	22

	Reflectorization .....	22
<b>3.2</b>	<b>Materials</b> .....	<b>26</b>
	Permanent Materials .....	26
	Paint .....	26
	Thermoplastic .....	27
	Two-component, Cold Curing .....	27
	Preformed Tape .....	27
	Temporary Materials .....	28
<b>3.3</b>	<b>Devices</b> .....	<b>28</b>
	Roadway Pavement Markers .....	28
	General .....	28
	Supplementing Other Markings .....	30
	Substituting for Pavement Markings .....	30
	Temporary RPMs .....	31
	Installation .....	31
	Maintenance .....	34
	Rumble Strips .....	34
<b>3.4</b>	<b>Lines</b> .....	<b>35</b>
	General .....	35
	Directional Dividing Lines .....	36
	General .....	36
	Criteria for Use .....	36
	Low-volume, Local Roadways in Urban Areas .....	37
	Low-volume, Rural Roads .....	37
	Roadways with Temporary Bituminous Surfaces .....	37
	Directional Dividing Lines at Specific Roadway Features .....	37
	Lane Lines .....	40
	General .....	40
	Rural Roads .....	40
	Urban Roads .....	40
	Edge Lines .....	41
	General .....	41
	Freeways and Multi-lane Roadways .....	42
	Two-lane Roadways .....	42
	Interchange Ramps and Channelization Lines .....	44

<b>3.5</b>	<b>Transition and Continuity Lines</b> .....	<b>50</b>
	Transition Lines .....	50
	Continuity Lines .....	50
<b>3.6</b>	<b>Interchange Ramps and Channelization Lines</b> .....	<b>53</b>
<b>3.7</b>	<b>Barrier Lines</b> .....	<b>53</b>
	General .....	53
	Lane Reductions .....	53
	Passing Zones (Truck Climbing Lanes and Added Passing Lanes) .....	56
	No-passing Zones .....	56
	Two-lane Roadways .....	56
	Criteria for Use .....	56
	Vertical Curves .....	59
	Horizontal Curves .....	66
	Narrow Bridges .....	69
	Approach Markings for Obstructions .....	69
<b>3.8</b>	<b>Intersections</b> .....	<b>71</b>
	Controlled Intersections .....	71
	STOP Signs .....	71
	Traffic Control Devices .....	71
	Guide Lines .....	80
	Crosswalks .....	80
	Turn Lanes .....	81
	Traffic Calming Devices .....	83
<b>3.9</b>	<b>Reserved Facility Markings</b> .....	<b>83</b>
	Transit and High Occupancy Vehicles .....	83
	Clearance and Vehicle Guidance .....	83
	Bus Bays .....	83
	Lane Designation .....	85
	Bicycles .....	89
	Lane Designation .....	89
	Markings .....	89
	Pedestrians .....	90
	Crossovers .....	90
	Crosswalks .....	97
	School Crossings .....	97

	Railways .....	99
	Crossing Approaches .....	99
<b>3.10</b>	<b>Parking .....</b>	<b>101</b>
	Stalls .....	101
	Type .....	101
	Length .....	101
	Width .....	101
	Setback .....	101
	Curb Markings and Restrictions .....	101
	Markings .....	101
	Restrictions .....	101
	Disabled Requirements .....	103
	Location .....	103
	Width .....	103
	Marking .....	103
<b>3.11</b>	<b>Coloured Pavement .....</b>	<b>103</b>
	General .....	103
	Colours .....	103
<b>3.12</b>	<b>Words and Symbols .....</b>	<b>104</b>
	Word Messages .....	104
	Symbols .....	104
<b>4.</b>	<b>Delineation .....</b>	<b>111</b>
<b>4.1</b>	<b>General .....</b>	<b>111</b>
	Purpose .....	111
	Colours .....	111
	Design .....	111
	Retroreflectivity .....	112
	Installation and Removal .....	112
	Maintenance .....	112
<b>4.2</b>	<b>Curb Markings for Delineation .....</b>	<b>113</b>
<b>4.3</b>	<b>Delineators .....</b>	<b>113</b>
	Colours .....	113
	Applications .....	113
	Roads, Ramps and Curves .....	113

	Acceleration and Deceleration Lanes .....	114
	Lane Width Transitions .....	114
	Median Emergency Crossovers .....	114
	Truck Escape Ramps .....	114
	Median Barrier Delineation .....	114
	Delineation for Winter Maintenance Operations .....	118
	Placement and Spacing .....	119
	Post-mounted Delineators .....	119
	Median Barrier Delineators .....	120
<b>4.4</b>	<b>Chevrons Alignment Sign .....</b>	<b>120</b>
	Purpose and Background .....	120
	Sign Types .....	120
	Guideline for Use .....	120
	Location Criteria .....	121
	Special Consideration .....	121
<b>5.</b>	<b>Object Markings .....</b>	<b>121</b>
<b>5</b>	<b>Object Markings .....</b>	<b>121</b>
	Purpose and Background .....	121
<b>5.1</b>	<b>Object Marker Signs .....</b>	<b>121</b>
	Sign Types .....	121
	Guidelines for Use .....	123
	Location Criteria .....	123
	Winter Maintenance Considerations .....	125
	Special Considerations .....	125
<b>5.2</b>	<b>Markings on Objects Adjacent to the Roadway .....</b>	<b>125</b>
<b>5.3</b>	<b>Markings on Objects Within the Roadway .....</b>	<b>125</b>
	Safety Zones, Islands, Median Dividers .....	127
	Bridge Piers .....	127
	Structures with Restricted Overhead Clearance .....	127
	Pavement Markings on Approaches to Obstructions .....	128
<b>5.4</b>	<b>Barricades .....</b>	<b>130</b>
<b>5.5</b>	<b>Channelizing Devices .....</b>	<b>131</b>



<b>6.</b>	<b>Glare Control</b> .....	<b>133</b>
6.1	<b>General</b> .....	<b>133</b>
	Purpose .....	133
	Types of Glare Control Devices .....	134
	Design .....	134
	Installation, Maintenance, and Removal .....	134
6.2	<b>Applications</b> .....	<b>134</b>
<b>Index</b>	.....	<b>135</b>
<b>Appendix A • Definitions</b>	.....	<b>139</b>
<b>Appendix B • References</b>	.....	<b>151</b>

**List of Tables**

Table 1 – Minimum Passing Sight Distances .....	56
Table 2 – Minimum Lengths of Passing Zones (Level Grade) .....	59
Table 3 – Length of Barrier Line in Advance of Right Curve (In Metres) .....	68
Table 4 – Spacing of Highway Delineators on Horizontal Curves .....	118
Table 5 – Spacing of Chevron Alignment Signs on Horizontal Curves .....	119
Table 6 – Minimum Length of Approach Markings (m) for Obstructions within the Pavement Area .....	130

**List of Figures**

Figure 1 – Glass Bead Retroreflection .....	17
Figure 2 – Prismatic Cube-corner Retroreflection .....	17
Figure 3 – Types of Markings .....	23
Figure 4 – Markings: Principles of Colour and Pattern .....	24
Figure 5 – RPMs Supplementing Pavement Markings .....	29
Figure 6 – Roadway Pavement Markers Substituting for Pavement Markings .....	32
Figure 7 – Temporary Roadway Pavement Markers .....	33
Figure 8 – Directional Dividing Lines on Rural and Urban Roads .....	38
Figure 9 – Marking for One-lane Bridge or Subway .....	43
Figure 10 – Freeway Off Ramps with Wide Lines .....	45

Figure 11 – Freeway On-Off Auxiliary Lane with Wide Lines .....	46
Figure 12 – Freeway Either/or Lane Off Ramps with Wide Lines .....	47
Figure 13 – Freeway On Ramps with Wide Lines .....	48
Figure 14 – Channelizations .....	49
Figure 15 – Transitions from Four to Two Lanes .....	51
Figure 16 – Transitions from Four to Two Lanes .....	52
Figure 17 – Two-lane Highway with Added Truck Climbing Lane .....	54
Figure 18 – Two-lane Highway with Added Truck Climbing or Passing Lane .....	55
Figure 19 – Two-lane Pavements .....	57
Figure 20 – Treatment of Ends of Barrier Lines on Two-lane Highways .....	58
Figure 21 – Method of Establishing No-passing Zones Using a Highway Profile .....	60
Figure 22 – Sketch Showing the Method of Establishing No-passing Zones on Vertical Curves .....	62
Figure 23 – Method of Establishing No-passing Zones for Successive Vertical Curves on Two-lane Pavements .....	65
Figure 24 – Method of Establishing No-passing Zones on Horizontal Curves .....	67
Figure 25 – Marking for Narrow Bridge or Subway .....	70
Figure 26 – Approaches to Rural Intersections .....	72
Figure 27 – Marking for Right-turn Lane .....	73
Figure 28 – Marking for Right-turn Taper .....	74
Figure 29 – Separate Left-turn Lane .....	75
Figure 30 – Left-turn Slip-around .....	76
Figure 31 – Approaches to Unsignalized Urban Intersections .....	77
Figure 32 – Signalized Intersection .....	78
Figure 33 – Location of “Keep Right” Sign at Signalized Urban Intersection .....	79
Figure 34 – Two-way Left-turn Lane .....	82
Figure 35 – Typical Markings for Bus Bays .....	84
Figure 36 – Typical Pavement Markings for Full-time With-flow Reserved Lanes .....	86
Figure 37 – Typical Pavement Markings for Full-time Contra-flow Reserved Lane .....	87
Figure 38 – Diamond Symbol for Reserved Lanes .....	88
Figure 39 – Typical Pavement Markings for Bicycle Lanes .....	91
Figure 40 – Typical Pavement Markings for Shared Bicycle and Pedestrian Facilities .....	92
Figure 41 – Typical Pavement Markings for Bicycle Lane at Right-turning Roadway .....	93
Figure 42 – Typical Pavement Markings for Bicycle Lane at Right-turning Auxiliary Lane .....	94
Figure 43 – Typical Pavement Markings for Bicycle Lane at Right-turning Roadway .....	95

Figure 44 – Typical Markings for Pedestrian Crossovers .....	96
Figure 45 – School Crosswalks for Supervised Crossing .....	98
Figure 46 – Railway Crossing .....	100
Figure 47 – Typical Markings for Parallel Parking .....	102
Figure 48 – Disabled Access Symbol .....	103
Figure 49 – Standard Pavement Markings (Numerals for Rural Highways) .....	105
Figure 50 – Standard Pavement Markings (Letters for Rural Highways) .....	106
Figure 51 – Standard Pavement Markings (Numerals and Letters for City Streets, Minimum Size) .....	108
Figure 52 – Standard Pavement Markings (Numerals and Letters for City Streets, Recommended Size) .....	109
Figure 53 – Standard Pavement Markings (Arrows) .....	110
Figure 54 – Ends of Divided Highways (Two Lane to Four Lane Divided – Offset Centre Lines) .....	115
Figure 55 – Ends of Divided Highways (Four Lane to Four Lane Divided) .....	116
Figure 56 – Ends of Divided Highways (Two Lane to Four Lane Divided) .....	117
Figure 57 – Typical Marker Location at Bridge Ends .....	122
Figure 58 – End Protection for Raised or Depressed Safety Zone .....	124
Figure 59 – Clearance Markings Low Clearance Structures .....	126
Figure 60 – Gore Areas (Non-freeway Use) .....	129
Figure 61 – Wire Glare Screen .....	132
Figure 62 – Baffled Glare Screen .....	133

**NOTE: A training package for Book 11 is available separately. For more information, contact:**

**Ministry of Transportation**  
 Traffic Program Management Office  
 301 St. Paul Street, 2nd Floor  
 St. Catharines, Ontario  
 L2R 7R4  
 Telephone: (905) 704-2960

---

# 1. Introduction

## 1.1 Purpose, Scope and Contents

In 1997, the Ministry of Transportation, Ontario undertook a study to reformat the “Manual of Uniform Traffic Control Devices” (MUTCD) for Ontario and combine it with the 1990 Ministry “King’s Highway Guide Signing Policy Manual” and the 1995 “Tourism-Oriented Directional Signing Policy”. The resulting recommendation from this assignment was the Ontario Traffic Manual (OTM), consisting of twenty-one Books, their proposed tables of contents, and a recommended style guide. OTM Book 1 is written as an introduction to the use and application of the other Books. Included as Appendices to Book 1 are the Illustrated Sign and Signal Display Index, Sign Design Principles, and Positive Guidance Toolkit. The other Books contain recommended practices for the use and application of traffic control devices throughout Ontario.

OTM Book 1 contains a listing of the Books forming the OTM series. Book 1 and its Appendices are provided with the purchase of each of the other Books. Book 1 should be read prior to the use and application of the other OTM Books. The use of any of the devices discussed in Book 11 should be considered in conjunction with the contents of the other OTM Books.

OTM Book 11 (Markings and Delineation) has been prepared to provide the user with a consistent way of utilizing pavement and curb markings, post-mounted delineators, object markers, and glare control devices to convey information to the driver. Section 1, “Introduction”, introduces Book 11 and explains its wording, classification conventions, and

the legal authority of road markings. Section 2, “General Principles”, provides an overview of the functions and conventions of road markings and delineation. Section 3 contains information on the application of pavement markings, Section 4 on delineators, Section 5 on object markers, and Section 6 on glare control devices. A separate training package is available to help the user with the successful application of Book 11.

The purpose of this Book is to promote uniformity of treatment in the design and installation of markings and delineation throughout Ontario. It is the practitioner’s fundamental responsibility to exercise professional engineering judgement on technical matters in the best interests of the public, including safety and cost-effectiveness. The following standard terminology will provide the user of this Book with guidance on what practices are recommended and when judgement can be applied:

**Must** indicates a mandatory condition. Where “must” is used to describe the design or application of the device, it is mandatory that these conditions be met in order to promote uniformity where delineation complements legally enforceable regulations. (“Must” replaces the expression “shall” in previous versions of the Ontario MUTCD.)

**Should** indicates an advisory condition. Where the word “should” is used, the action is recommended but is not mandatory. “Should” is meant to suggest good practice in most situations and to recognize that there may be valid reasons not to take the recommended action.

**May** indicates a permissive condition. No requirement for design or application is intended. However, once a specific option is chosen, mandatory requirements might apply.

For the purposes of Book 11, markings and delineation are classified as follows:

### **Pavement Markings**

- Materials
- Directional Dividing Lines
- Lane Lines
- Edge Lines
- Transition and Continuity Lines
- Interchange Ramps and Channelization Lines
- Barrier Lines
- Intersection Markings
- Reserved Facility Markings
- Parking Markings
- Coloured Pavement
- Words and Symbols

### **Delineation**

- Delineators
- Chevrons

### **Object Markings**

- Markings on Objects Adjacent to the Roadway
- Markings on Objects Within the Roadway
- Barricades
- Channelizing Devices

### **Glare Control**

For a more detailed classification of marking and delineation devices, the reader should refer to OTM Book 1, Section 7.3 (Classification of Markings and Delineation). For more detailed information on roadway marking and delineation techniques, the reader should refer to the U.S. Federal Highways Administration (FHWA) report, *Roadway Delineation Practices Handbook*. The FHWA publication is intended to help the practitioner determine the appropriate delineation system for a specific situation.

In a given situation, the selection and application of the traffic control device(s) depends on various factors such as the classification of the highway or roadway on which it will be applied.

In the OTM, highways and roadways have been classified as:

### **Freeway**

An expressway with full control of access and interchanges in place of at-grade intersections. This includes Toll Highways built to a freeway configuration.

- **Urban** typically includes:
  - main roadways with more than two lanes
  - high traffic volumes
  - closely spaced interchanges
  - roadway and interchange lighting
  - three or more interchanges serving major city
- **Rural** typically includes:
  - longer interchange spacing
  - high speed traffic
  - sign placement for maximum conspicuity

## Non-freeway

Roadways with at-grade intersections for roads and private access points.

- **Urban** typically includes:
  - multi-lane expressways with at-grade intersections
  - major urban roads and streets
  - local streets
- **Rural** typically includes:
  - non-freeway King's Highways
  - rural regional roads
  - rural county roads
  - rural local roads

## 1.2 Legal Authority

Provincial legislation provides that markings may be placed by the road authority having jurisdiction for the purpose of regulating, warning or guiding traffic (Section 182 of the Highway Traffic Act (R.S.O. 1990)).

Pavement and curb markings, being exclusively within the boundaries of public highways, should only be placed by the road authority. Delineators and object markers that are within the highway right-of-way are subject to the same jurisdictional regulations.

Markings and delineation serve an advisory or warning function, and do not have legal force of their own. They may be used to complement other traffic control devices enforceable under the HTA, its Regulations, or a municipal by-law, but their enforceability derives from the main regulatory traffic control device, not from the markings or delineation. To avoid possible conflict or confusion, the meaning of markings and delineation should be checked against the prevailing traffic laws and regulations before they are installed or removed.

## 1.3 Standardization

Where pavement markings, delineators and object markers are used, they must be uniform in design, position and application so that road users can recognize and understand them immediately.

Pavement markings, delineators and object markers must be used only to convey the meaning as prescribed for them in Book 11. The following sections describe various types of standard pavement markings, covering a variety of conditions and situations frequently encountered on public highways and roadways. Markings must conform to the principles and guidelines laid out in Section 2 and subsections 3.1, 4.1, and 5.1 of Book 11, even if they are applied in conditions or situations not specifically described in this Book.

---

## 2. General Principles

### 2.1 Functions of Markings and Delineation

Pavement markings and delineation devices fulfill an important guidance function for drivers, especially at night. They provide drivers with information about their lane position and which lanes are available for use. They provide drivers with a preview of upcoming changes in the roadway, including curves, lane drops, lane narrowings, intersections, crosswalks, and the beginning and end of passing zones. Good delineation generally results in better driver performance and greater driver comfort.

Road markings and delineation often supplement other traffic control devices, such as signs and signals. Sometimes they are used alone to obtain results that could not be achieved using any other device, conveying regulations and warnings that would not otherwise be clearly understood.

In Ontario, warning and guide signs are not considered part of markings and delineation. Refer to OTM Book 6 (Warning Signs) and OTM Book 8 (Directional Guide Signs) for detailed information regarding their application.

### 2.2 Limitations

The road authority should provide markings and delineation that are highly visible during all weather and light conditions. However, pavement markings can be obscured by snow, ice, debris, water, fog, or glare, or worn by heavy traffic. Under favourable

conditions, pavement markings and delineation provide the advantage of warning or informing drivers without diverting their attention from the roadway.

The limitations of pavement markings in particular are discussed further in Section 3.1 of this Book.

### 2.3 Delineation and Driver Requirements

Drivers require long range guidance information about the roadway ahead, including the presence of curves or lane drops. Driver requirements for delineation have been established through studies of lane tracking at different preview distances. According to some studies, markings and delineators should be visible for a minimum of two seconds preview time, since driver control of lane position begins to deteriorate below a minimum of two seconds of preview distance. At 50 km/hr, two seconds' preview distance would be 28 m and at 100 km/hr would be 56 m. Other studies have determined that a minimum of three seconds is required. At 50 km/hr, three seconds' preview distance would be 42 m and at 100 km/hr would be 83 m. Further studies have recommended five seconds of preview time for optimum driver comfort. It is generally recognized that surface markings typically are sufficient to provide two seconds of preview time, while longer preview times require the use of roadway pavement markers or post-mounted delineators.

The visibility of markings and delineators is a function of delineation characteristics, lighting levels, and driver factors. Delineation characteristics include contrast, colour, and retroreflectivity. Artificial lighting levels are determined by headlight and fixed light source distributions. Driver factors include age and sensitivity to contrast.

## Contrast

Delineation visibility is dependent on the contrast between delineation and its pavement background. Contrast is the difference in luminance between a target (for example, a lane line) and its background (for example, asphalt or concrete). Contrast is expressed mathematically as:

$$C = \frac{L_t - L_b}{L_b}$$

Where: C = Contrast  
 $L_t$  = Target Luminance  
 $L_b$  = Background Luminance

Lane control has been shown to be a function of the logarithm of contrast. At first, lane control improves rapidly as contrast is increased. As contrast continues to increase lane control improvement declines. Contrast values of two to three give most drivers adequate preview distance.

## Illumination

Visibility is partly determined by the relative luminance (or reflectivity) of the marking and the road surface. In daylight, the marking and road surface illumination are essentially identical. By contrast, the marking and pavement illumination resulting from headlighting is extremely varied, depending on the particular headlight beam, its mounting height, the difference in height between the driver's eye and the headlight beam, and the headlight beam pattern. Because headlights emit so little light, retroreflective beads in the pavement marking are used to concentrate the amount of light reflected back towards the driver's eyes. Therefore the nighttime visibility of markings and delineators by headlights depends on retroreflectivity.

## Retroreflectivity

Retroreflectivity is a measure of the incident light returned toward the source. For pavement markings, the key measurement is the coefficient of retroreflected luminance,  $R_L$ , measured in candelas per lux per square metre (cd/lux/m<sup>2</sup>).

Retroreflectors reflect light in a fairly narrow cone about the angle of incidence. Light reflected exactly at the angle of incidence returns to the headlight. If a material were a perfect retroreflector, it would be of no assistance to the driver. The driver's eye is above the headlight and receives the portion of retroreflected light that is "imperfectly" reflected, close to the angle of incidence. For this reason, an imperfect retroreflector is desirable.

Retroreflectivity can be achieved by using glass beads or prismatic cube-corners. Figure 1 illustrates glass bead retroreflection and Figure 2 illustrates prismatic cube-corner retroreflection.

- **Glass beads** are primarily used with durable pavement marking materials. Glass beads have two properties, transparency and roundness, which permit them to retroreflect light. Glass beads must be transparent so that light can pass into the sphere. Their rounded shape allows light to be bent downward towards a point below where the bead is embedded in the paint. Light striking the back of the paint-coated bead surface is reflected back towards the path of entry. If the paint were not present, the light would continue through the bead and be scattered in many directions. The use of glass beads in pavement markings is discussed in Section 3.2 of this Book.
- **Prismatic cube-corners** are used in roadway pavement markers and as prismatic sheeting for retroreflective delineators and object markers. Prismatic retroreflection is achieved through the



use of many tiny half-cube retroreflective elements. Light enters the cube and reflects off each mirrored face, exiting at an angle nearly equal and opposite to the angle of entry.

According to the FHWA *Roadway Delineation Practices Handbook*, several researchers have found that drivers rate pavement markings on dry roads as adequate or better when the coefficient of retroreflected luminance,  $R_L$ , is 0.1 cd/lux/m<sup>2</sup>. On wet roads, approximately twice as much retroreflectivity is required to achieve the same subjective ratings. Mirolux 12 and the Ecolux 12 retroreflectometers were used by the researchers. Retroreflectometers are discussed in Section 2.7 of this Book.

### Driver Factors

Sensitivity to contrast decreases with age. At threshold levels of detection, the average 65 year-old driver requires twice as much contrast as a 23 year-old. Consequently there is significant driver variability in detection distance. For example, a retroreflective pavement marking visible at 160 m to the average younger driver is not visible to the average older driver until 105 m. Older drivers are further disadvantaged because information handling slows with age.

Sight distance is based on a complex interplay of delineation size, contrast, and retroreflectivity. Driver responses do not improve in direct proportion to increases in light levels or delineated area size. For example, doubling the width of the pavement marking increases sight distance by 16%, whereas doubling its level of retroreflectivity increases sight distance by 43%. Computer models such as PCDETECT use data on driver contrast thresholds, headlight beam patterns, and target characteristics to predict sight distances with different types of markings and delineators.

## 2.4 Colours

All pavement markings and delineation must be either white, yellow, or orange as specified in Section 3.1 of this OTM Book. In addition, blue and red may be used in specific applications described in Sections 3.3, 3.10, 3.11, and 4.1 of this Book.

Black may be used in combination with the above colours where a light-coloured pavement does not provide sufficient contrast with the markings. When used in this way, black is considered a contrast enhancer, not a marking colour. Black is a usable colour for object markers.

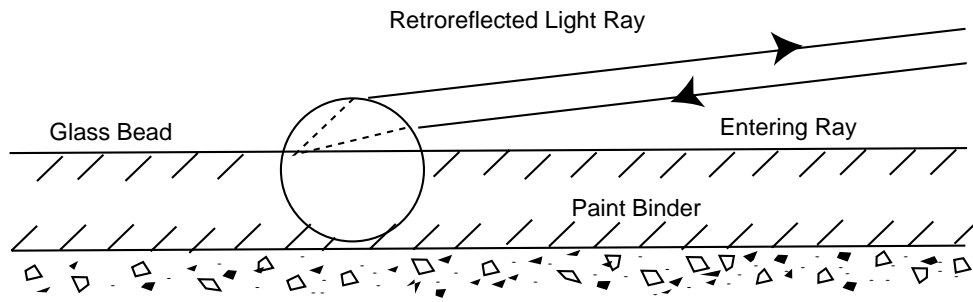
## 2.5 Materials

Pavement markings are commonly placed using paints or more durable products. Other suitable devices, including roadway pavement markers, may also be used. At the roadside, delineators and object markers may also be used in a vertical position, similar to signs. The material used must provide the specified colour throughout its service life, should be selected for its durability in accordance with its expected application, and should be environmentally friendly.

Marking material used near pedestrian activity should not present tripping or slipping hazards. Object markers and delineators must not present a vertical or horizontal clearance hazard for pedestrians.

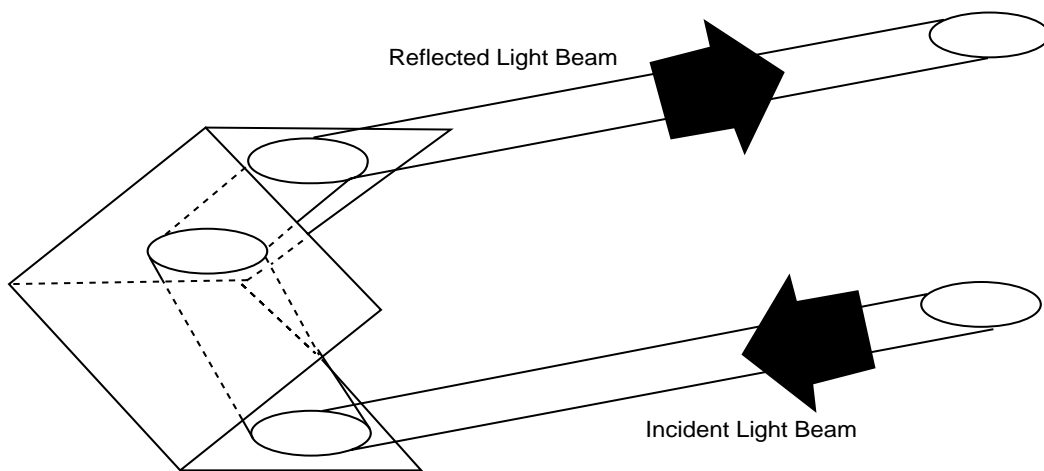
When applying delineation materials, reference should be made to the requirements outlined in OTM Book 4 (Maintenance and Operations). In all cases, manufacturer's installation specifications should be acquired and followed.

Figure 1 – Glass Bead Retroreflection



Source: U.S. Federal Highways Administration

Figure 2 – Prismatic Cube-corner Retroreflection



Source: U.S. Federal Highways Administration

## 2.6 Application

Before any new roadway, temporary alignment, or detour is opened to traffic, all necessary markings and delineators should be in place.

Factors that are considered in determining the appropriate markings or delineation are:

- Roadway functional classification;
- Roadway geometry;
- Local weather and regional climate;
- Traffic volume and composition; and
- Road surface.

These factors affect the marking material and application technique and will determine the marking's visibility and durability.

Cost considerations will influence the type and application of delineation. Products should be chosen on the basis of expected cost, service life, and benefit/cost comparisons.

Benefit/cost comparisons can be based on variables such as:

- The type, scope, and expected duration of the delineation system;
- The cost of materials and installation;
- Life-cycle costs;
- Maintenance requirements;
- The local availability of materials and equipment;

- Liability issues; and
- Expected collision reductions.

Tradeoffs must often be made among divergent and conflicting concerns. However, in all instances, it is imperative to follow the functional requirements described in this Book.

## 2.7 Temporary Conditions

OTM Book 7 (Temporary Conditions) specifies temporary delineation markings and colours for barrels, cones, barricades, and channelization devices used in construction and maintenance work zones.

The materials used for temporary markings should be selected on the basis of their life expectancy, durability, and the ease and effectiveness of their application and removal. For more detailed information on temporary roadway marking and delineation techniques, refer to the U.S. Federal Highways Administration (FHWA) *Roadway Delineation Practices Handbook*.

Temporary roadway pavement markers are often used in construction and maintenance zones. They are easy to install and remove, and when removed do not leave marks that could confuse drivers.

Where temporary markings are placed in accordance with the principles of colour and pattern described in Section 3.1 of this Book, temporary roadway pavement markers may be used as an enhancement. Temporary roadway markers may also be used to provide short term delineation in construction zones prior to the placement of permanent markings. In such short-term uses, temporary roadway pavement markers take the place of short-term markings that are normally applied. Where a line of temporary roadway pavement markers is used as an alternative to

temporary markings, the result must be comparable to temporary pavement markings and conform to the principles of colour and pattern described in Section 3.1 of this Book.

## 2.8 Removal

Markings that are no longer applicable or no longer define the safe path of travel must be removed, masked, or obliterated as soon as practical. Traditionally, markings are removed by sandblasting, grinding, or chipping. Less commonly, markings can be removed by chemical means, high-pressure water jet, hot compressed-air burning, or excess-oxygen burning. Removal should not damage the road surface or texture.

Thermoplastics are generally more difficult than paints to remove effectively, since the properties that enhance their durability, such as thickness and integral bond with the pavement, inhibit their removal. Permanent tapes can be the most difficult to remove, particularly if a good bond was achieved during application. Temporary tapes are fabricated to be easily removed by hand.

Painting over invalid markings with black paint or bituminous solutions is not a proper removal technique. The covering material is susceptible to wear, so that the invalid markings will eventually reappear. Further, markings covered in this way remain visible under some low-light conditions, due to differing reflections from the roadway surface and the covering material.

## 2.9 Maintenance

To achieve the safest possible delineation system, roadway delineation must be carefully maintained. A maintenance program typically consists of the following components:

- (1) **Defining maintenance criteria**  
Maintenance criteria are often taken as minimum retroreflectivity values, where the minimum value for the coefficient of retroreflected luminance is generally considered to be no less than 0.1 cd/lux/m<sup>2</sup>.

Alternatively, some jurisdictions adopt the retention of adequate material to meet minimum delineation needs. For example, replacement of roadway pavement markers may be mandated when three or more consecutive markers are missing.

- (2) **Establishing inventory**  
An inventory of markings may be compiled using a computer database or photolog. The type of delineation device, its location, the material used, and its current state may be recorded.

- (3) **Inspection**  
Periodic inspections should be made after installation of a delineation system and at regular intervals during its service life. These inspections should be conducted both daytime and night-time.

Field testing techniques may be adopted to quantify the retroreflectivity of delineation (using retroreflectometers) and inspect the condition of retroreflective glass beads (using a pocket microscope).

Permanent markings must be replaced when they are no longer effective. They are typically renewed with an overlay of compatible material. In addition, roadway delineation is subject to the following maintenance requirements:

- Cleaning of surfaces stained by tire tracks, particularly on bituminous surfaces;

- Patching of delineation material lost on unstable pavements or on pavements where the bond is weak or faulty;
- Replacement of delineation material removed or paved over during roadworks;
- Replacement of delineation material (particularly roadway pavement markers) removed or damaged by unusual traffic or snowploughs.

During maintenance, the following factors should be considered:

- Crew and road user safety;
- Compatibility of new and old delineation materials (if new material is to be overlaid);
- Integrity of substrate material;
- Condition (cleanliness, moisture content, temperature) of substrate material; and
- Protection of the renewed delineation until it is able to withstand traffic.

### Retroreflectometers

A retroreflectometer is used to measure retroreflectivity. A retroreflectometer is basically a photometer with a particular measurement geometry, set up to measure luminance from a particular observation and entrance angle, and simulating as closely as possible the geometry between pavement markings, the driver's eye and the headlight.

The headlight strikes the marking at a grazing angle – almost 90 degrees. In order to determine whether the light level meets driver requirements, it should be measured from a distance of approximately 60 m, which is equivalent to at least two seconds away at 100 km/h.

Unfortunately, it is difficult to create an instrument capable of making such measurements. Consequently, retroreflectometers typically compromise, using entrance angles that are not as grazing as in reality (e.g., 86.5 degrees rather than 89 degrees), and bringing the marking closer – to between 10 m and 30 m, rather than 60 m – so that the observation angle is increased, and larger aperture (and therefore less expensive) instruments can be used.

Since retroreflectometers vary in the entrance and observation angles used, they will obtain different luminance measures depending on the measurement geometry. Thus it is important to use the same measuring instrument when comparing different products.

Reflectometers are usually classified by fine and coarse geometry. Fine geometry instruments closely simulate the entrance and observation angles experienced by a driver, while coarse geometry instruments do not. Therefore, the fine geometry instruments are much better at predicting subjective ratings of effectiveness. The U.S. Federal Highways Administration's (FHWA) *Roadway Delineation Practices Handbook* lists a number of fine geometry reflectometers currently in use in the U.S., including the Mirolux 12, Ecolux, Erichson and Optronik brands (all of which measure at 13 m using an entrance angle of 86.5 degrees). The handbook gives correlations between various devices and

concludes that, when the instruments have been properly calibrated, the fine geometry retroreflectometers usually correlate within about 10% of each other.

Currently, there is no common standard instrument for measuring retroreflectivity, and different manufacturers use different instruments. The FHWA is moving towards the specification of a standard measuring instrument using 30 m geometry.

---

## 3. Pavement Markings

### 3.1 General

#### Types

Major marking types include lines, intersection markings, reserved facility markings, parking markings and coloured pavements.

#### Function

Pavement markings provide guidance and information to road users without diverting their attention from the road. Markings may be used as the sole source of guidance or control for road users, or to supplement other traffic control devices such as signs, signals and other markings.

Roadway delineation may include devices with audible and tactile features such as bars, profiled surfaces, and roadway pavement markers. By generating noise and vibration when they are traversed by motor vehicle tires, these types of markings alert the motorist to changes ahead or warn of unsafe deviations from the normal travel lane.

In Ontario, pavement markings alone have no regulatory function. Pavement markings may be used to provide regulatory information to the road user, but associated signage must be in place as outlined in OTM Book 5 (Regulatory Signs).

## Limitations

Pavement markings have limitations related to their visibility, durability, and applicability:

- Pavement markings are not necessarily clearly visible on wet pavement, and can be obscured by snow or by accumulations of debris, dust, or dirt, particularly adjacent to a median, curb, or unpaved shoulder. In winter, a dry salt film may compromise the visibility of pavement markings. The view of pavement markings, particularly transverse markings or mid-lane symbols, can be blocked by traffic.
- Pavement markings have limited durability on surfaces exposed to heavy traffic wear. Roadway pavement markers are particularly susceptible to removal by snowploughs.
- Pavement markings cannot be applied to unsealed roads.
- Certain types of pavement markers affect skid resistance, particularly for motorcycles and bicycles. If motorcycles and bicycles are expected to use the road, pavement marking materials should be carefully chosen and requirements for large marked surfaces should be carefully reviewed.

## Colours

Pavement markings are generally white or yellow unless otherwise stated in this Book. Blue and red may be used in specific applications described in Sections 3.3, 3.10, 3.11, and 4.1 of this Book. Orange may be used in some applications. Black is not a standard colour, but may be used in the gaps of a broken pavement line to heighten contrast where the pavement colour is too light for adequate definition.

Figures 3 and 4 detail principles of colour and pattern for pavement markings.

## Reflectorization

In order to remain effective at night, pavement markings should be retroreflective. Retroreflectivity is achieved by using glass beads or prism facets to reflect light from vehicle headlights back to the driver.

The retroreflectivity of road markings is enhanced by applying glass beads to the surface of freshly applied marking material, or incorporating them in a striping tape. The beads form a reflective coating on the surface of the striping material. Conventional glass beads used on road markings are 0.150 mm to 0.650 mm in diameter. Larger beads about 1 mm in diameter can enhance the retroreflectivity of pavement markings, particularly in wet weather, but tend to require more frequent replacement and are susceptible to removal by snowploughs.

Glass beads can be sprayed under pressure, dropped onto wet marking material, or incorporated into the marking material. With time and wear, the embedded beads can become exposed. Optimum embedment of the glass beads in the marking material is 55% to 60%.

Cube corners are used in roadway pavement markings and post-mounted delineators. A series of cube corners are moulded in a transparent plastic medium. Light entering the front of the reflector is internally reflected at each of three cube faces in turn, then emerges parallel to the incident angle. This is a newer methodology than glass beads, and achieves greater visibility by reflecting more incoming light toward the driver. High performance depends on each facet of the cube corner being almost a perfect optical flat and making a precise angle with its neighbouring facets.

Figure 3 – Types of Markings

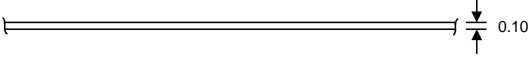
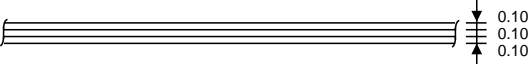
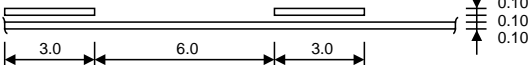

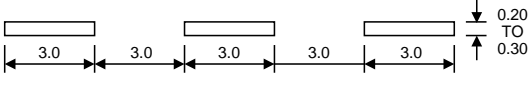
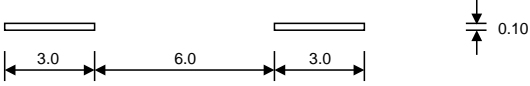
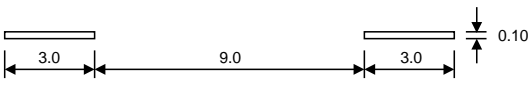
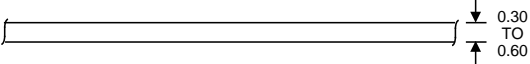
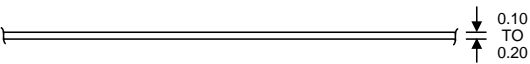
		NAME OF LINE	DIMENSIONS (m)	USE
LONGITUDINAL		SOLID		EDGE LINES (WHITE OR YELLOW), DIRECTIONAL DIVIDING LINES (YELLOW), LANE LINES PROHIBITING LANE CHANGES (WHITE)
		DOUBLE SOLID		DIRECTIONAL DIVIDING LINES (YELLOW)
		SIMULTANEOUS SOLID AND BROKEN		DIRECTIONAL DIVIDING LINES TWO-WAY LEFT-TURN LANES (YELLOW)
		CONDENSED BROKEN		GUIDING LINES (E.G. INTERSECTION MOVEMENTS) (WHITE)
		WIDE BROKEN		CONTINUITY LINES (WHITE)
		BROKEN		DIRECTIONAL DIVIDING LINES (YELLOW) URBAN LANE LINES, LOW SPEED (WHITE)
		BROKEN		LANE LINES (WHITE) HIGH SPEED ROADWAY
TRANSVERSE		STOP		INTERSECTION STOP LINES (WHITE)
		CROSSWALK		CROSSWALKS (WHITE)



Figure 4 – Markings: Principles of Colour and Pattern

(1) LONGITUDINAL PAVEMENT MARKINGS BETWEEN VEHICULAR TRAFFIC LANES

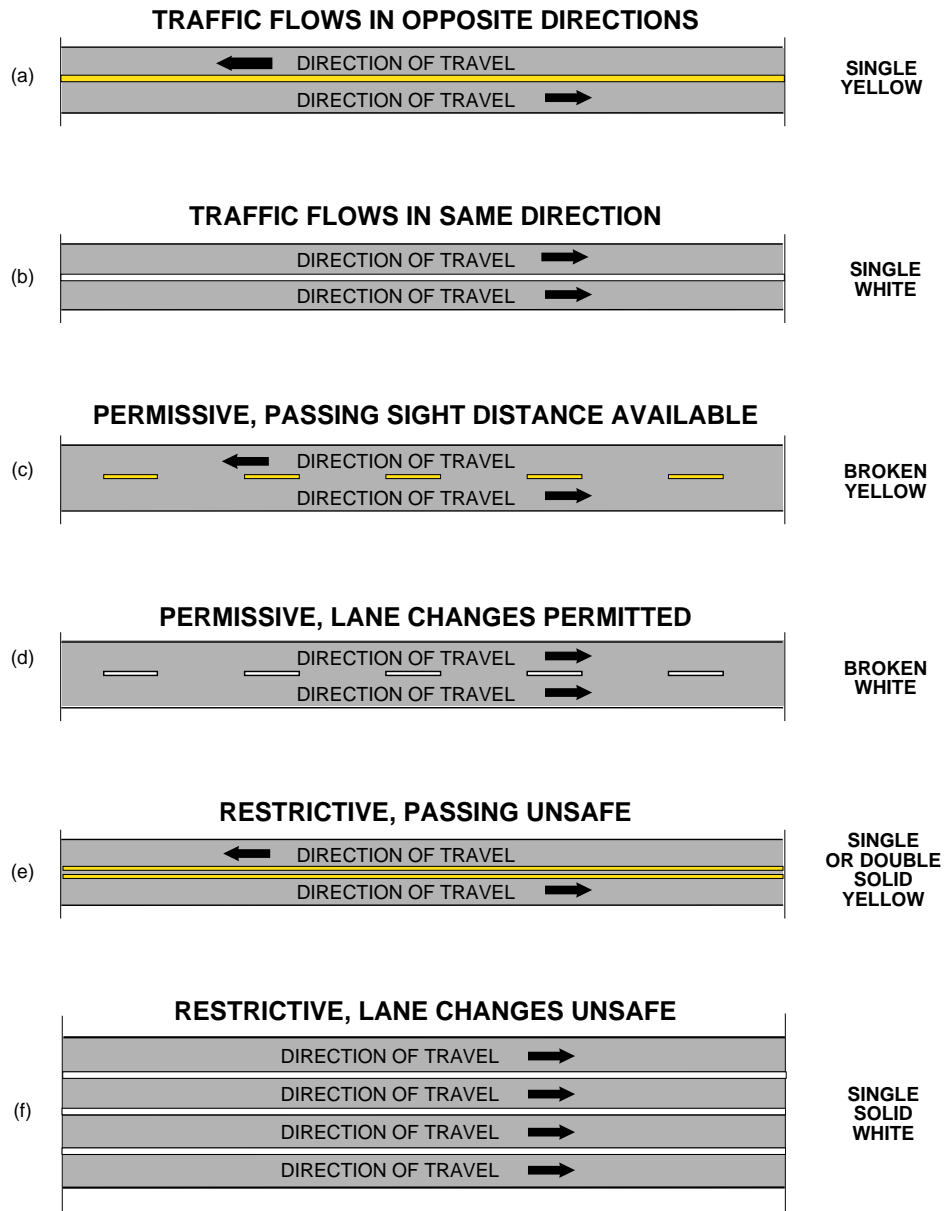
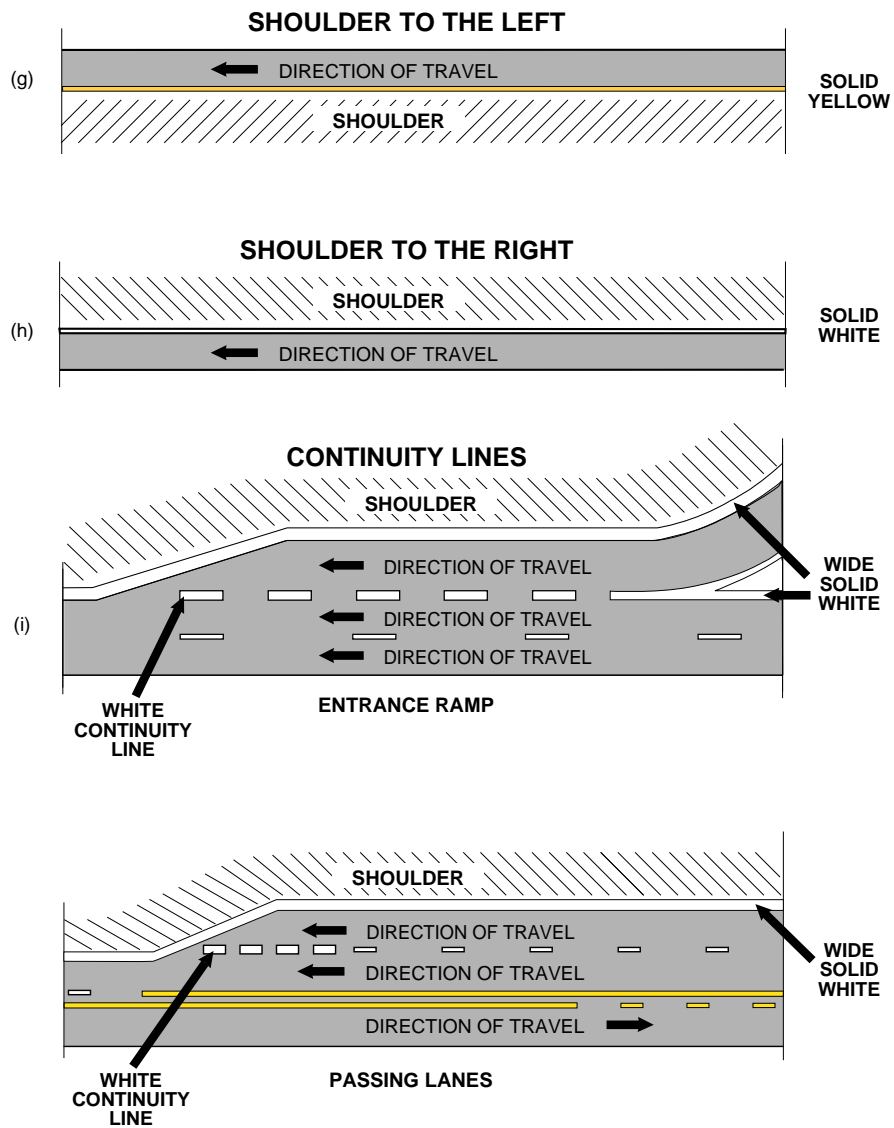


Figure 4 – Markings: Principles of Colour and Pattern (cont'd)

(2) BETWEEN VEHICULAR TRAFFIC LANES AND SHOULDERS



## 3.2 Materials

### Permanent Materials

Pavement markings can be applied using paint and more durable products. These markings may be enhanced by devices such as roadway pavement markers and rumble strips (discussed in Section 3.3), delineators (discussed in Section 4), and object markers (discussed in Section 5).

Paints, durable marking materials, and preformed tapes are briefly described in this section. For more detail concerning the performance, installation, maintenance, removal, inspection, and environmental impacts of these materials, refer to the 1994 U.S. Federal Highways Administration publication, *Roadway Delineation Practices Handbook*, on which the following discussion is based.

Durable markings such as thermoplastics, two-component cold-reacted materials and tapes tend to have higher profile than paint. This makes them more susceptible to damage, particularly by snowploughing. Their durability can be extended significantly, however, if they are made flush with the surrounding pavement. Pre-formed tapes can be rolled into freshly laid asphalt. By first routing a channel into the pavement, then laying the marking material, other types of durable materials can be inlaid as well.

#### Paint

A paint system contains three interactive elements:

- The paint itself (pigment and binder), discussed below;
- Retroreflective glass beads, if any. Beads can reflect differently depending on the binder used, its thickness, and the proportion of pigment;

- The substrate or pavement surface. Paints can react differently on asphaltic and concrete pavements. About 90% of all paint failures are due to the type of substrate and condition of the surface.

Paint can be hot-applied or cold-applied. Drying times vary from less than 30 seconds (instant-drying paints) to over 7 minutes (conventional paints).

Five main types of paint are available:

- **Alkyd and modified alkyd paints** are generally the cheapest and fastest-drying, but are the least durable. During application, these paints release volatile organic compounds (VOCs), a potential environmental hazard.
- **Chlorinated-rubber or chlorinated-polyolefin paints** are more durable than alkyd and modified alkyd paints, but have a longer drying time and strong odour.
- **Water-based latex paints** avoid the use of hazardous VOCs and lead-based pigments and have service lives as long as or longer than alkyd and chlorinated-rubber paints, but have longer drying times and less colour durability.
- **Two-component epoxy paints and polyester paints** are not as widely used as alkyd, rubber, and latex paint. Their long-term performance is still under observation. Epoxy paint may be of particular value in Ontario due to its expected resistance to abrasion from snow removal equipment and materials.

The estimated service life of painted markings is a function of a number of site-specific variables, including the type and condition of the substrate, the climate, and the average daily traffic. Most highway agencies consider a reasonable target service life to be between six and twelve months under normal conditions. On roads with very high

traffic flows, a service life of three months is considered acceptable; on roads with low traffic flows, a service life of one to two years can be expected.

### *Thermoplastic*

Durable marking materials typically last three to fifteen times longer than painted markings, but have a higher initial cost. When durability is a prime concern, hot-applied thermoplastic materials are considered a cost-effective alternative to conventional paint markings. Thermoplastic is considered impervious to deicing chemicals and sand.

Hot-applied thermoplastics are synthetic resins that soften when heated and harden when cooled without changes to their inherent properties. A thermoplastic system contains three interactive elements:

- The thermoplastic itself (plastic and plasticizer binder, pigment, and fillers);
- Retroreflective glass beads, if any;
- The substrate or pavement surface.  
Thermoplastics are not appropriate for application on new portland cement concrete.

Thermoplastic markings are classified by the type of binder used. The two most commonly used thermoplastic types are alkyd-based and hydrocarbon-based. Hydrocarbon-based thermoplastic should not be used for transverse markings because it can be dissolved by oil drippings.

Although thermoplastic is regarded as the most durable delineation material, its installation, maintenance, and removal requires great care compared with paint. The high temperature required for application and the extreme heat sensitivity of

the material require a high level of quality control. Thermoplastics can be applied by hot extrusion (requiring two to ten minutes' drying time) or hot spray (requiring less than one minute's drying time).

### *Two-component, Cold Curing*

Methyl methacrylate is a two-component cold-curing material that can be applied by either a spray or extrusion process. Just before application, it is mixed in a static mixer, generating an exothermic reaction. As the material cools, it bonds to the pavement.

### *Preformed Tape*

Cold-applied preformed marking tape is appropriate for use at sites where a small quantity of marking material is required. Preformed tape is relatively easy to install and repair, which makes it especially useful where heavy use or severe conditions can make frequent replacement necessary.

Limited observation of the performance of preformed tape indicates that it is generally durable, but requires careful application. Its retroreflectivity tends to diminish over its service life. Because of its high initial cost, preformed tape is considered a cost-effective alternative to conventional paint or thermoplastic markings only in limited circumstances.

Preformed tape is generally supplied in rolls or sheets, usually with a pressure-sensitive adhesive backing. It ranges in thickness from about 0.75 mm to 2.5 mm. A tape marking system contains two interactive elements:

- The preformed tape itself (resin binder, pigment, and fillers, with optional glass beads and adhesive); and

- The substrate or pavement surface. Preformed tapes are reported to perform better on bituminous asphalt surfaces than on portland cement concrete.

Preformed tapes are classified as permanent or temporary, according to their expected service life. Permanent tapes, with an expected service life greater than one year, are typically made of urethane or pliant polymer.

Preformed tapes are either inlaid on freshly-laid warm asphalt or overlaid on existing pavement. Installation requires great care, and a clean pavement is more important for preformed tapes than for any other pavement marking material. If applied improperly, adhesion failure is likely to result.

### Temporary Materials

Temporary tapes are used for temporary markings in construction and maintenance work zones. Temporary tape is designed to be easily removed by hand, without heat, solvents, grinding, or sandblasting.

Temporary preformed tapes generally consist of a single layer of pigmented binder and glass beads applied to a backing layer of metal foil. They are applied by overlaying them on the road surface, using the tape's preapplied adhesive for bonding. A primer will enhance pavement bond. Because they are intended for short-term use, temporary preformed tapes generally have a shorter expected service life than permanent preformed tapes.

## 3.3 Devices

### Roadway Pavement Markers

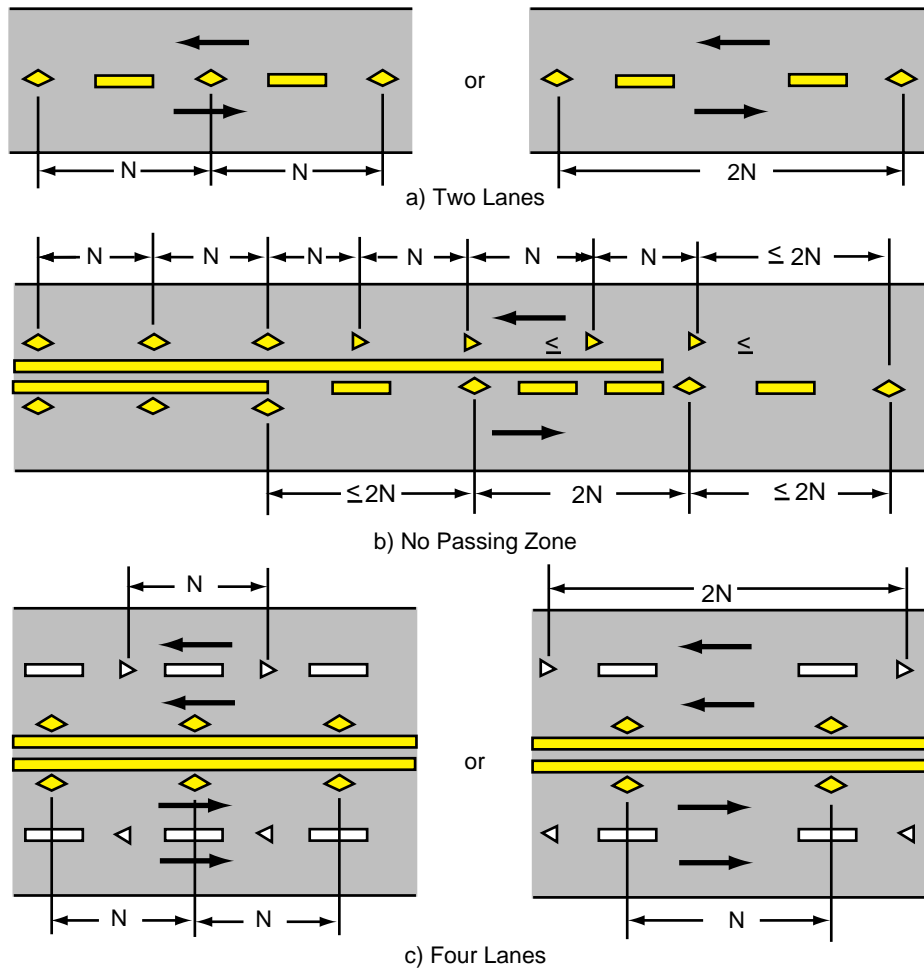
#### *General*







A roadway pavement marker (RPM) is a device mounted on or in the road surface to supplement or replace pavement markings. The greatest advantage of RPMs is the enhanced visibility they provide at night under wet or foggy conditions, compared to painted or durable markings. Another advantage is that motorists who accidentally stray across a line of RPMs will be alerted by a rumbling noise. This can be especially useful if drivers are fatigued or inattentive.

RPMs have also been found to help lower driver stress in adverse conditions. Studies have shown that in wet weather and other conditions motorists guided by pavement markings alone become increasingly agitated and make potentially dangerous errors in positioning their vehicles laterally in the lane. When pavement markings are supplemented by RPMs, driver performance quickly recovers and stress levels return to normal.

However, RPMs have a higher initial cost than other markings, are susceptible to loss, and are subject to lens damage (cracking and abrasion) that greatly reduces their retroreflectivity. Due to their high initial cost, RPMs should not be installed on roads that will be reconstructed or resurfaced in the near future.

Figure 5 – RPMs Supplementing Pavement Markings



Code:	N	Normal Spacing		Yellow Stripe
		Single white		White Stripe
		Single Yellow		Direction of Traffic
		Double Yellow		

Note: "N" is the combined length of one line segment and one gap in a broken line configuration appropriate to the road under consideration. "N" varies between 4.5 m and 12 m, as described in Section 3.4.

Source: U.S. Federal Highways Administration, Roadway Delineation Practices Handbook.

*Supplementing Other Markings*

RPMs may be used to supplement other markings such as directional dividing lines, lane lines, edge lines, guide lines, and continuity lines. They are particularly useful at hazardous locations such as channelizations, bridge approaches, lane transitions, horizontal curves, construction zones, and at approaches to obstructions.

For spacing and positioning of RPMs, refer to the following guidelines. (N is the combined length of one line segment and one gap in a broken-line configuration appropriate to the road under consideration.)

- When supplementing solid line markings, RPMs should be spaced no more than N, as shown in Figure 5. However, when supplementing left edge line markings, RPMs should be spaced at intervals of no more than N/2. RPMs should not be used to supplement right edge line markings.
- When supplementing broken line markings, RPMs should be spaced in gaps between segments, at intervals of N or 2N, as shown in Figure 5. When supplementing broken line markings that identify reversible lanes, a spacing of no more than N should be used.
- When supplementing guide lines, a RPM should be used for each short line segment.
- When supplementing continuity lines, RPMs should be spaced at intervals of N/2.

Closer RPM spacing may be necessary when marking patterns for specialized applications at transition areas, intersection approaches, sharp curves, left-turn lanes, and freeway ramps.

Red reflectors, usually placed on the downstream side of a bidirectional RPM, may be used to warn road users that they are traveling the wrong way on a one-way street or ramp.

These devices should be properly maintained to ensure legibility and visibility. In order to command respect and attention, they should be removed or covered when they are no longer appropriate.

*Substituting for Pavement Markings*

When used as a substitute for pavement markings, RPMs should be entirely retroreflective. The pattern of RPMs should simulate the pattern and match the colour of the markings for which they are substituted so that the message conveyed to drivers is consistent.

RPMs are normally restricted to simulating lane lines or centre lines and should not be substituted for edge line markings.

For spacing of RPMs, refer to the following guidelines. ("N" is the combined length of one line segment and one gap in a broken-line configuration appropriate to the road under consideration.)

- When replacing a lane line, RPMs should be placed as shown in Figure 6(a).
- When replacing a directional dividing line on two-way, two-lane roads where passing is permitted, RPMs should be placed as shown in Figure 6(b).
- When replacing barrier lines on two-way roads where passing is prohibited, RPMs should be placed as shown in Figure 6(c) if passing is prohibited in both directions, and as shown in Figure 6(d) if passing is prohibited in one direction only. At least one marker in four should be a monodirectional retroreflective RPM oriented toward the vehicles in the no-passing direction.

Spacing may be reduced to alert the road user to changes in the travel path, such as at sharp curves or in transition areas where lanes are dropped or shifted.

#### *Temporary RPMs*

Temporary RPMs (TRPMs) can be utilized in construction and maintenance zones. TRPMs are surface mounted and are preferred to painted or thermoplastic markings because they are easily removed and leave no misleading residual markings behind.

TRPMs may be placed in groups as an alternative to temporary markings, provided their placement adequately simulates the visual display of and conforms to the specifications for colour and pattern for normal temporary pavement markings.

TRPMs may be placed individually only as an enhancement to temporary pavement markings except when placed to provide short-term delineation in construction zones prior to the placement of permanent markings. When used for this purpose, TRPMs must take the place of the short-term marking normally applied.

Figure 7 shows suggested spacing of temporary directional dividing lines using RPMs. Spacing is based on a value of "N", which is the combined length of one line segment and one gap in a broken-line configuration appropriate for the road under consideration. The traffic practitioner should use a similar interval and spacing between temporary concurrently flowing lanes.

In areas of heavy traffic, TRPMs should be regularly monitored and missing RPMs should be replaced.

#### *Installation*

RPMs must conform both day and night to colour and pattern specifications for longitudinal lines described in Sections 2.3 and 3.4 of this Book.

Good adhesion is the single most important determinant of a TRPM's durability. The major factors that affect pavement bond are properties of the bonding agent, design of the RPM's bonding surface, type of pavement, temperature, moisture content, and care in application.

Retroreflective RPMs may be reflective in one direction (monodirectional) or two (bidirectional). Care should be taken to use the appropriate reflectivity as RPMs can confuse road users if they are visible to them but do not apply to their direction of travel.

Retroreflective RPMs should be oriented so that their reflectivity is fully exploited. On small-radius curves, RPMs might need to be installed so that their reflective faces are aimed toward approaching traffic, rather than tangentially to the curve.

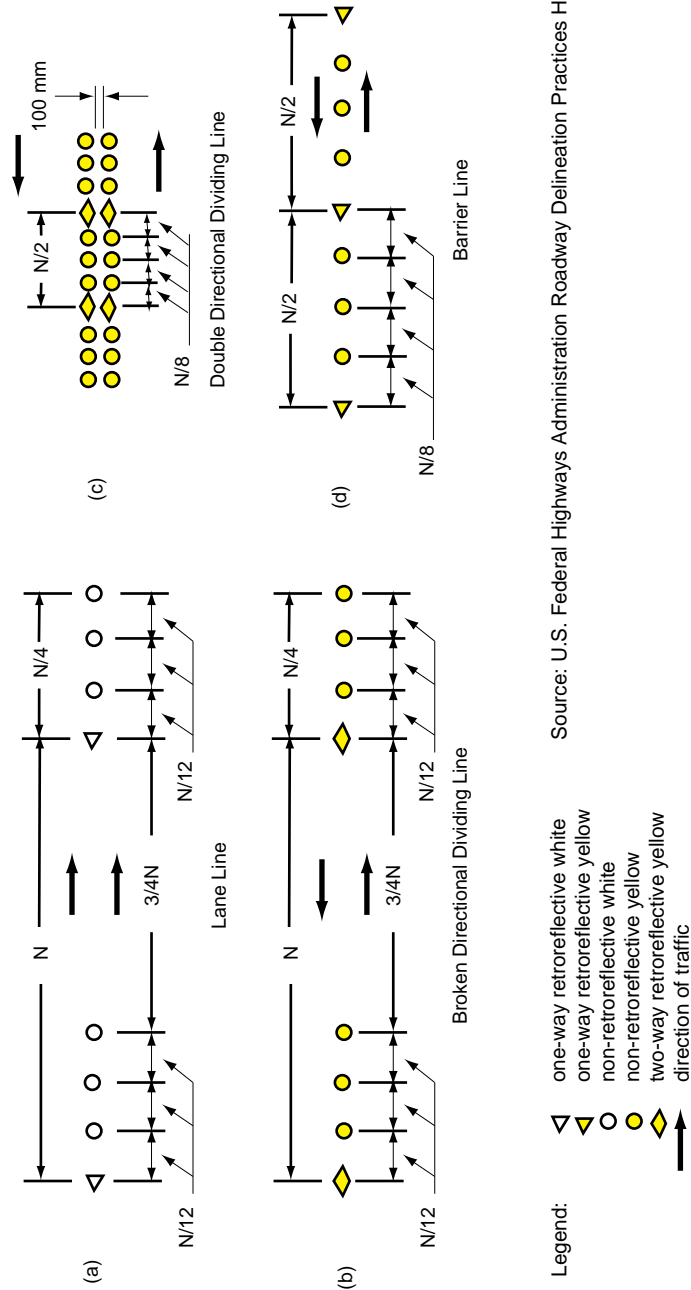
When RPMs are used to enhance delineation in a hazardous area, they should be introduced slightly in advance of the area to prepare road users for their use as a new guidance technique.

RPMs used to supplement painted or durable lines can be unintentionally obliterated by marking material during remarking operations if they are placed too close to an existing line. For this reason, RPMs should be installed far enough from an existing line to allow for a margin of error during remarking operations.

RPMs should not be used on cyclists' likely travel paths unless the lane shared by vehicles and cyclists is at least 4 m wide, giving cyclists adequate space to avoid the RPMs.



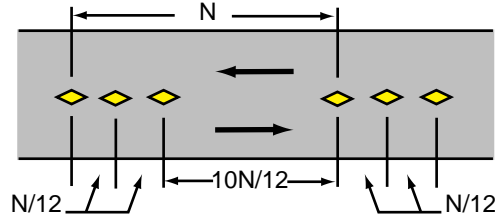
Figure 6 – Roadway Pavement Markers Substituting for Pavement Markings



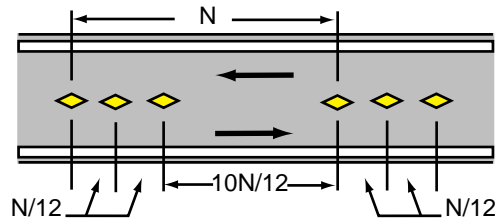
Source: U.S. Federal Highways Administration Roadway Delineation Practices Handbook

Figure 7 – Temporary Roadway Pavement Markers

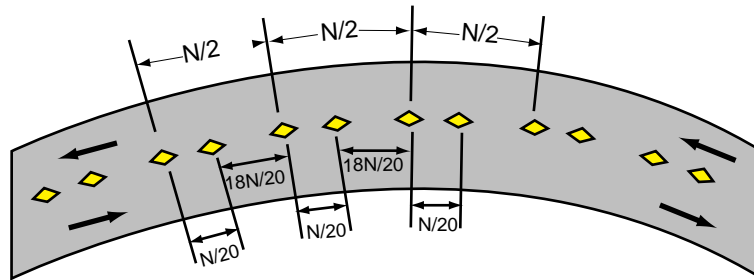
(a) Two-lane two-way road (14 days or less)




(b) Two-lane two-way road (over 14 days)



(c) Two-lane two-way road with severe curvature (14 days or less)



Legend:  two-way reflective yellow  
 "N" is the combined length of one line segment and one gap in a broken line configuration appropriate to the road under consideration. "N" is generally 9m as described in section 3.4

Source: U.S. Federal Highways Administration Roadway Delineation Practices Handbook

RPMs are susceptible to removal by snowploughs. When used in areas or during seasons when snowploughing is common, RPMs must be designed and installed to be snowploughable, or inset so that their upper surface is flush with the pavement to avoid destruction. Where markers are recessed to withstand snowploughing, the grooves in which they are set can collect debris, rain, snow, or sand, reducing the visibility of the inset markers. Ongoing cleaning of the grooves may not be practicable. An alternative is the snowploughable RPM, which consists of a steel casing that guides the snowplough blade up and over the plastic retroreflective unit. If properly installed, snowploughable markers can usually withstand ploughing, although snowplough blades can damage their replaceable lenses. Lenses can also lose retroreflectivity through abrasion or cracking.

### *Maintenance*

Abrasion of the lens can affect the performance of retroreflective RPMs. Studies conducted in other jurisdictions have concluded that abrasion and dirt can cause retroreflective RPMs to lose 70% to 95% of their initial retroreflectivity within the first year of installation. For this reason, regular inspection and replacement of abraded RPMs is an essential element of their maintenance program.

Road sections employing RPMs should undergo scheduled routine maintenance inspections according to their expected service life and future plans for the maintenance of the roadway. High traffic volumes, especially truck traffic, can reduce longevity. In some areas, vandalism and vehicle collisions affect average service life. Inspections are normally conducted by maintenance staff, and normally require only that inspectors drive a roadway section at night, evaluating RPM visibility and counting the number missing. RPMs should be replaced when three or more consecutive RPMs are missing or significantly damaged.

In addition to abrasion and other forms of damage, RPMs can be compromised by the presence of road film, salt dust, or soil dust. RPMs are normally cleaned of road film or dust during wet weather by the action of passing traffic. Cleaning RPMs is not normally part of a regular maintenance schedule.

### **Rumble Strips**

Rumble strips generate vibration and noise when vehicle tires traverse them, thus alerting motorists. Two distinct types of devices fall within this definition:

- **Longitudinal Rumble Strips**

Longitudinal rumble strips are placed in long, continuous ribbons on paved or partially paved shoulders, adjacent to the traveled portion of the roadway. They are intended to alert motorists that they have strayed from the travel lane.

- **Transverse Rumble Strips**

Transverse rumble strips are placed in clusters, at intervals, across the travel lane and paved or partially paved shoulders, if present. They are intended to alert the motorists in the vicinity of traffic control devices, or of site-specific hazards.

Rumble strips may consist of:

- Grooves cut or impressed directly in the pavement; or
- Profiled strips which stand above the pavement.

Rumble strips consisting of a profiled strip which stands above the pavement surface can be achieved through the application of durable marking materials, or groups of non-retroreflective roadway pavement markers.

Before installing a rumble strip, possible reductions in road traction and interference with motorcycles and bicycles should be considered. Because rumble strips can present a hazard for cyclists, the observed or expected number of bicycles using the shoulder should be considered. If possible, sufficient space should be provided on the shoulder for cyclists to safely avoid the rumble strip. If this is not possible, the needs of cyclists can best be met by cutting low-profile grooves in the pavement, since cut grooves usually provide a traveling surface free of the raised bumps or wide undulations present with the other methods.

Rumble strips may be inappropriate in quiet residential areas, since they are audible outside a vehicle as well as inside. Grooves cut or impressed into the pavement may also accelerate its deterioration.

### 3.4 Lines

#### General

Lines are used to organize traffic into proper lanes, advise motorists where passing is prohibited, and supplement other warning devices. These markings help reinforce the limits of the travel path without diverting the driver's attention from the roadway.

Principles of colour and pattern for pavement markings are detailed in Figures 3 and 4.

- (1) When used as dividing lines between traffic lanes, longitudinal pavement markings must conform to the following principles:
  - (a) yellow lines delineate the separation of traffic flows in opposing directions;

- (b) white lines delineate the separation of traffic flows in the same direction;
- (c) yellow broken lines are permissive, and indicate that adequate passing sight distance is available and passing is permitted where traffic allows;
- (d) white broken lines are permissive, and indicate that lane changing is permitted where traffic allows;
- (e) solid yellow lines are restrictive, and indicate that passing is unsafe and is not permitted;
- (f) solid white lines are restrictive, and indicate that lane changing is unsafe and is not permitted.

Passing may be unsafe due to insufficient passing sight distances, the presence of intersecting roads nearby, or other operational concerns.

- (2) When used as dividing lines between traffic lanes and shoulders, longitudinal pavement markings must conform to the following principles:
  - (a) solid yellow edgelines delineate the separation of traffic lanes and shoulders when the shoulder is to the left of the traffic lane in the direction of travel;
  - (b) solid white edge lines delineate the separation of traffic lanes and shoulders when the shoulder is to the right of the traffic lane in the direction of travel;

- (c) broken white lines extend edge lines across merging and diverging areas. Their function is to delineate the edge of the through roadway and clearly define the space available for manoeuvring.
- (3) Wide lines are used for emphasis in areas where standard markings are inadequate, such as at merging and diverging areas. Where a wide line is used in conjunction with standard pavement markings, it must be at least twice as wide as the standard markings.

### Directional Dividing Lines

#### *General*

Directional dividing lines are used to designate the portion of a two-way roadway available for traffic traveling in each direction.

Depending on whether or not passing is permitted, a directional dividing line may consist of either a:

- Single, solid, yellow line;
- Single, broken, yellow line;
- Double, solid, yellow line; or
- Single, solid, yellow line paired with a single, broken, yellow line.

Double line markings are only required where permissive passing opportunities must be indicated by direction of travel, where the posted speed limit is 70 km/h or more, or where additional emphasis of a passing prohibition is required.

A broken directional dividing line consists of a 3 m line segment, followed by a 6 m gap. Double line markings are generally separated by one line-width.

Refer to Section 3.7 for a discussion of barrier lines and passing prohibitions.

Directional dividing lines are generally placed to coincide with the geometric centre of the pavement, but may be placed off-centre in order to make the most efficient use of the roadway. Typical examples of off-centre positioning are:

- Pavement width transitions;
- Added turning lanes at intersections;
- An uneven number of lanes on vertical or horizontal curves with limited sight distance;
- An urban street with parking permitted on one side only;
- An urban roadway with an uneven number of traffic lanes, having the extra lane allotted to the predominant direction of flow;
- An urban roadway where reversible lane operation is used to accommodate peak-hour directional volumes;
- Truck climbing or passing lanes.

#### *Criteria for Use*

Directional dividing lines are required throughout the entire length of all multi-lane roadways.

Directional dividing lines are not required on one-way roadways.

Directional dividing lines must be extended on both sides of a painted or flush-type median, as shown in Figure 8.

Directional dividing lines are discontinued through major roadway intersections.

Directional dividing lines are generally required throughout the length of all two-lane, two-way roadways. However, continuous directional dividing lines may not be necessary and/or practicable under the following circumstances:

- On low-volume, local roadways in urban areas;
- On low-volume, rural roadways;
- On roadways with temporary bituminous surfaces.

*Low-volume, Local Roadways in Urban Areas*

Two-lane, urban roadways which do not fulfil an arterial function and which have a two-way, peak-hour volume of less than 500 vehicles may not require a continuous directional dividing line. Requirements for short sections of directional dividing line at specific roadway features are outlined below.

*Low-volume, Rural Roads*

Low-volume, rural roadways must be marked according to the following:

- Along their entire length, if 6 m wide or more, and carrying a two-way, peak-hour volume of 200 vehicles or more;
- Along their entire length, if 5.5 m to 6 m wide or more, and carrying a two-way, peak-hour volume of 100 vehicles or more;
- Along their entire length, if 5 m to 5.5 m wide, and carrying a two-way, peak-hour volume of 50 vehicles or more;
- Continuously, along any section where the collision experience indicates a need to define the division between opposing traffic streams;
- Continuously, in any area with heavy night traffic or tourist traffic; and
- Continuously, in any area where the roadway is likely to be obscured frequently by fog or other atmospheric conditions.

Rural roadways which, based on width, do not exceed the volume thresholds outlined above, and which do not exhibit the collision, traffic or climactic conditions outlined, need only be marked at specific roadway features. Requirements for short sections of directional dividing line at specific roadway features are outlined below.

*Roadways with Temporary Bituminous Surfaces*

Roadways of this type need only be marked at specific roadway features. Requirements for short sections of directional dividing line at specific roadway features are outlined below.

*Directional Dividing Lines at Specific Roadway Features*

Where a continuous directional dividing line is determined to be impracticable or unnecessary, short segments of directional dividing line are required at specific roadway features. These include:

- Vertical curves;
- Horizontal curves;
- Intersections;
- Crosswalks;
- Crossovers;
- Railway crossings;
- Bridges;
- Subways; and
- Obstructions within the roadway.

Figure 8 – Directional Dividing Lines on Rural and Urban Roads

## RURAL

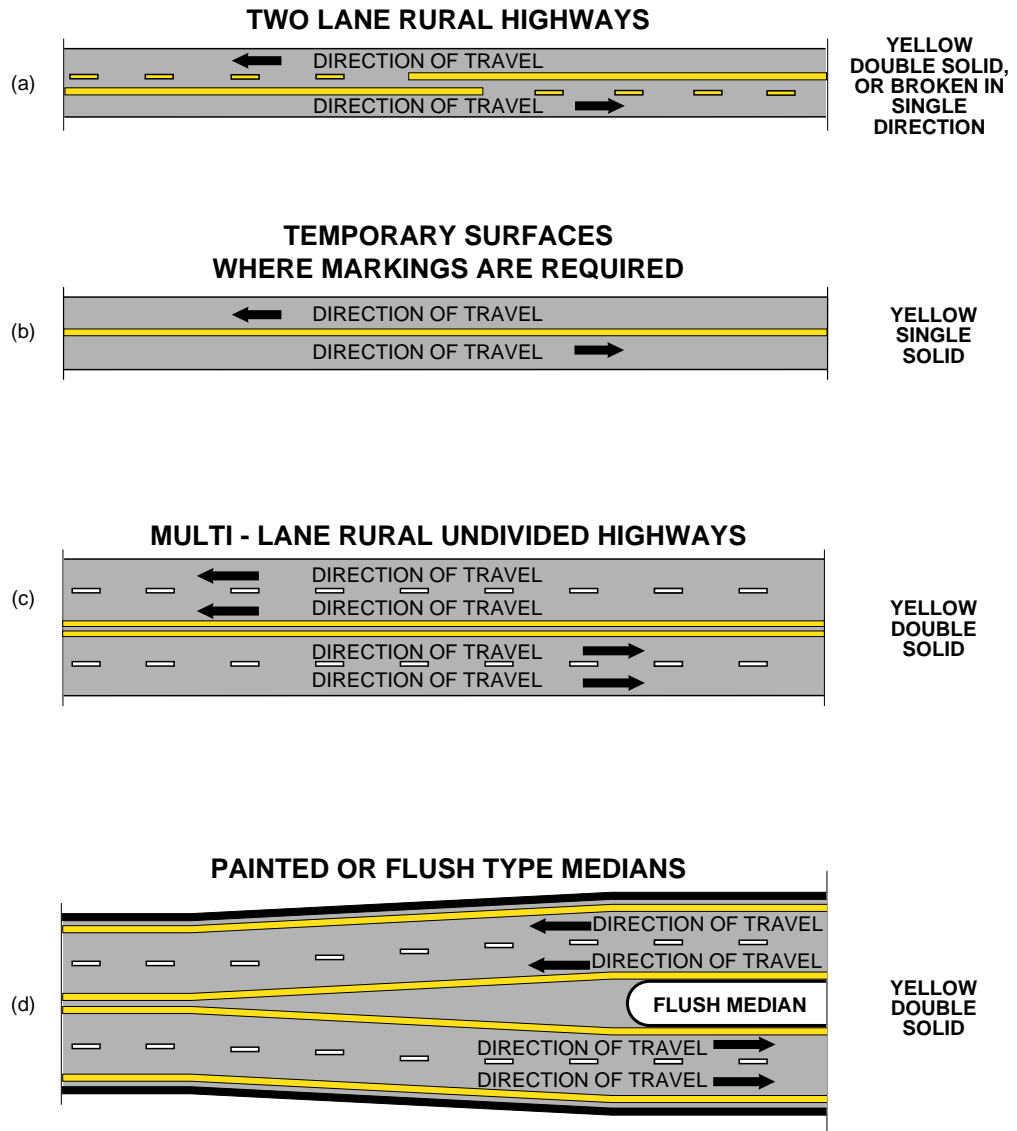
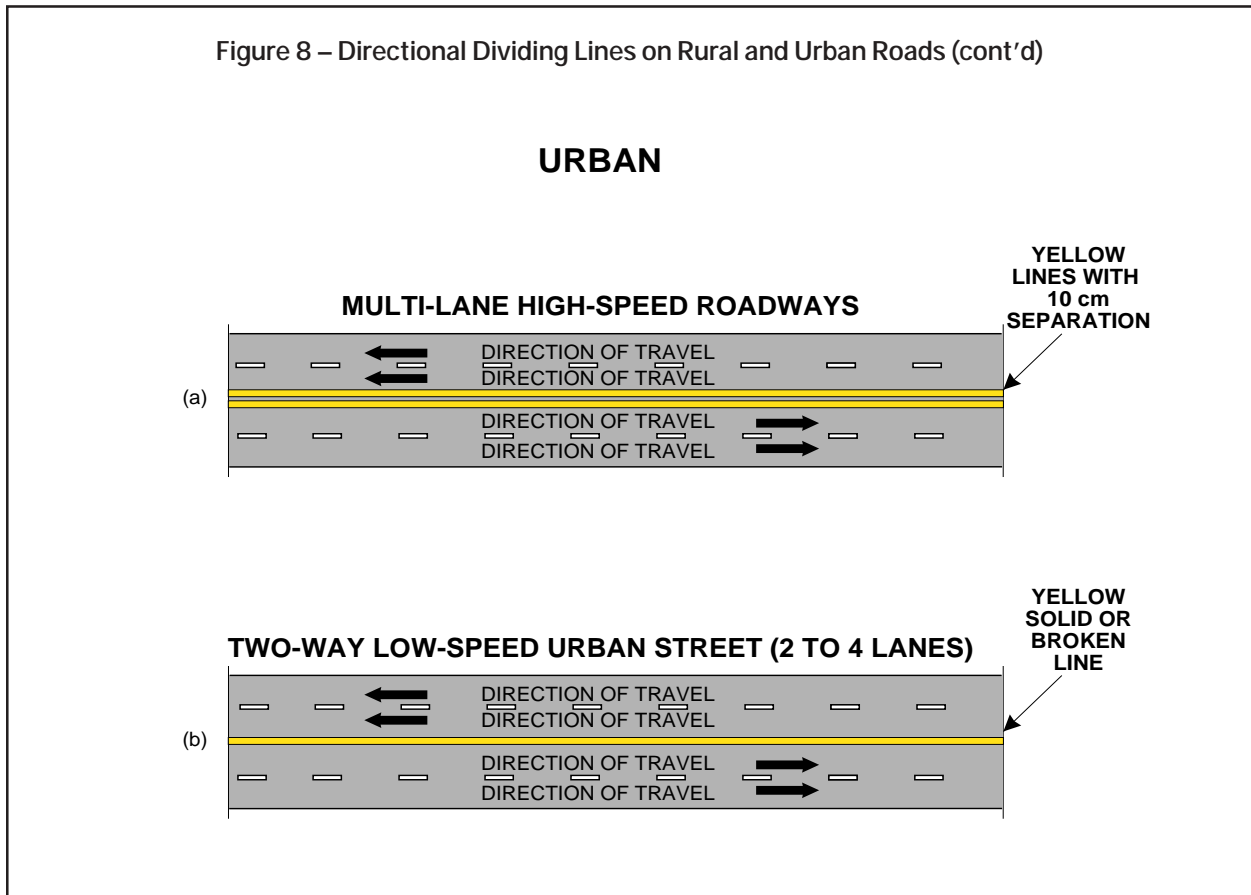


Figure 8 – Directional Dividing Lines on Rural and Urban Roads (cont'd)



On temporary bituminous and rural two-lane roadways, where the directional dividing line is not continuous, these locations should be marked as follows:

- Along the approaches to the crest of a hill where the available sight distance is less than 150 m;
- From 30 m in advance through 30 m beyond any curve having a radius of less than 180 m (10 degrees of curvature or greater), or where the sight distance is less than 150 m;
- On the approach to a through highway, for a minimum of 60 m from the stop line. A greater distance may be necessary where longer queues are normal, sight-lines are restricted, or higher operating speeds are common;
- At least 30 m in advance of any intersection, crosswalk, crossover or railway crossing; and
- In advance of any bridge, subway or obstruction within the roadway as outlined in Section 3.7.



## Lane Lines

### *General*

Lane lines are used to separate traffic lanes that move in the same direction. Lane lines organize traffic in its proper channels, and promote the efficient use of the roadway at congested locations.

Lane lines should be used where the following conditions exist:

- On rural and arterial urban highways having two or more adjacent lanes for traffic moving in the same direction;
- At the approaches to intersections with other roads;
- At crosswalks;
- At crossovers;
- In hazardous locations on rural highways and city streets; and
- At congested locations, particularly on city streets, where the roadway has to accommodate more lanes of traffic than would be possible without lane lines, including but not restricted to:
  - between loading islands and sidewalk curbs;
  - where the normal lane width is decreased; and
  - at approaches to widened intersections.

Normally, lane lines break at intersections unless the situation warrants extra guidance information to the driver. Line breaks help drivers to quickly identify an approaching intersection and are especially helpful at night when visibility is limited.

### *Rural Roads*

On a rural road where lane changes are permitted, the lane line must be a broken white retroreflective line approximately 10 cm wide, composed of 3 m segments separated by 9 m gaps, as shown in Figures 3 and 4.

Where lane changes are discouraged, a lane line must be a solid white retroreflective line approximately 10 cm wide as shown in Figure 4. This solid lane marking may be used to separate through traffic lanes from auxiliary lanes, such as left- or right-turn lanes, or to separate traffic lanes at the approach to an intersection.

Lane width, defined by the transverse spacing of lane lines, should be at least 3 m and no wider than 4 m, unless the lane is a shared-use lane.

### *Urban Roads*

On urban streets where lane changes are permitted, lane lines must be broken white retroreflective lines, approximately 10 cm wide, and should be composed of 3 m segments separated by 6 m gaps. The following exceptions apply:

- On high speed roadways with posted speed limits of 90 km/hr or above, the gap may be increased to 9 m;
- Where approach speeds are 60 km/hr or lower, as at intersections or between islands and curbs, the line segments may be as short as 1.5 m with gaps of 3 m.

Where lane changes are discouraged, a lane line must be a solid white retroreflective line approximately 10 cm wide, as shown in Figure 4. This solid lane marking may be used to separate

through traffic lanes from auxiliary lanes, such as at exit or entry lanes, to denote preferential lanes, or to separate traffic lanes at the approach to an intersection.

At approaches to major intersections it is common to give drivers extra guidance information through the use of the solid white lane line. This line warns drivers to exercise caution when considering a lane change.

Lane width, defined by the transverse spacing of lane lines, should be at least 3 m, but a minimum of 2.75 m may be used where the roadway width is limited and efficient lane use is important, as at signalized intersections, on bridges and in subways.

On sharply curved sections of urban streets, lane widths must be increased to accommodate off-tracking by long vehicles. At such locations, and also on tangent sections where the roadway width between the directional dividing line and the curb exceeds 6 m, the lane line must be placed to make the lane next to the curb up to 1 m wider than the adjacent lane in the same direction.

On multi-lane urban arterial streets with posted speed limits of 70 km/h or 80 km/hr, and on controlled access highways in urban areas, the lane markings must be the same as for rural highways.

A combination of markings is sometimes useful to help solve unusual traffic problems. For example, traffic backups are common during peak periods on urban streets. The application of reversible lane markings to provide extra lanes can alleviate this problem. Caution should be exercised with these markings, so that drivers (especially tourists and other drivers who are unfamiliar with the traffic patterns) are not confused. The use of regulated signs or traffic signals together with the lane markings and lane controls can help to support and guide the driver.

## Edge Lines

### *General*

Edge line markings delineate the outside edges of the traveled pavement. Edge lines adjacent to gravel shoulders and on or adjacent to partially paved shoulders reduce shoulder maintenance and collision frequencies while providing effective travel lane delineation, particularly in conditions of poor visibility. Because low-beam headlights are aimed down and to the right, solid edgelines can be seen considerably further at night than directional dividing lines located in the centre of the road, especially when the directional dividing line is broken.

Drivers often use edgelines as a guide in poor lighting conditions such as at night or in fog. If an oncoming driver has failed to dim the headlights, the approaching driver may look to the edge line for guidance.

Pavement edge line markings must be continuous single solid retroreflective lines approximately 10 cm wide. Edge lines to the right of a travel lane (when viewed by the driver) must be white; edge lines to the left of the travel lane must be yellow.

To delineate the pavement edge or separate the shoulder from the traveled lane, line markings must be used as follows:

- Where the shoulder is paved;
- 120 m in advance of, under, and over all one-lane bridges or subways, as shown in Figure 9;
- 150 m in advance of and around all curves having an advisory speed less than the posted speed limit;
- In merging and diverging lanes;

- At pavement width transitions;
- Where obstructions on the shoulder are within 60 cm of the pavement edge or the edge of the traveled lane, posing a potential hazard to traffic;
- Where there are unusual physical conditions or frequent occurrences of fog;
- On the median and shoulder edges of all freeways;
- On both sides of all interchange ramps; and
- On both sides of all channelization lanes.

Pavement edge line markings may be omitted on low-speed urban roadways with non-mountable curb and gutter, provided that the traveled lane is immediately adjacent to the curb.

Edge lines must not be continued through intersections with other roadways. Edge lines should be carried through driveways and private or commercial entrances that meet the roadway unless the access is signalized. Breaking the edge lines for minor accesses would disrupt the guidance which they provide to the driver.

#### *Freeways and Multi-lane Roadways*

Where the shoulders are fully paved, the edge lines must be placed on the shoulder directly adjacent to the edge of the traveled roadway.

On freeways where shoulders are gravel or partially paved, and the lane widths are 3.6 m or more prior to marking, the edge lines must be placed at a distance from the median and shoulder edge of the traveled lane so that the marked lane is consistently 3.3 m wide.

Where the lane widths are less than 3.6 m prior to marking, the edge lines must be placed 15 cm from the median and shoulder edges of traveled lane, unless the shoulders are partially paved, in which case the edge lines must be placed to provide a marked lane width of 3.3 m.

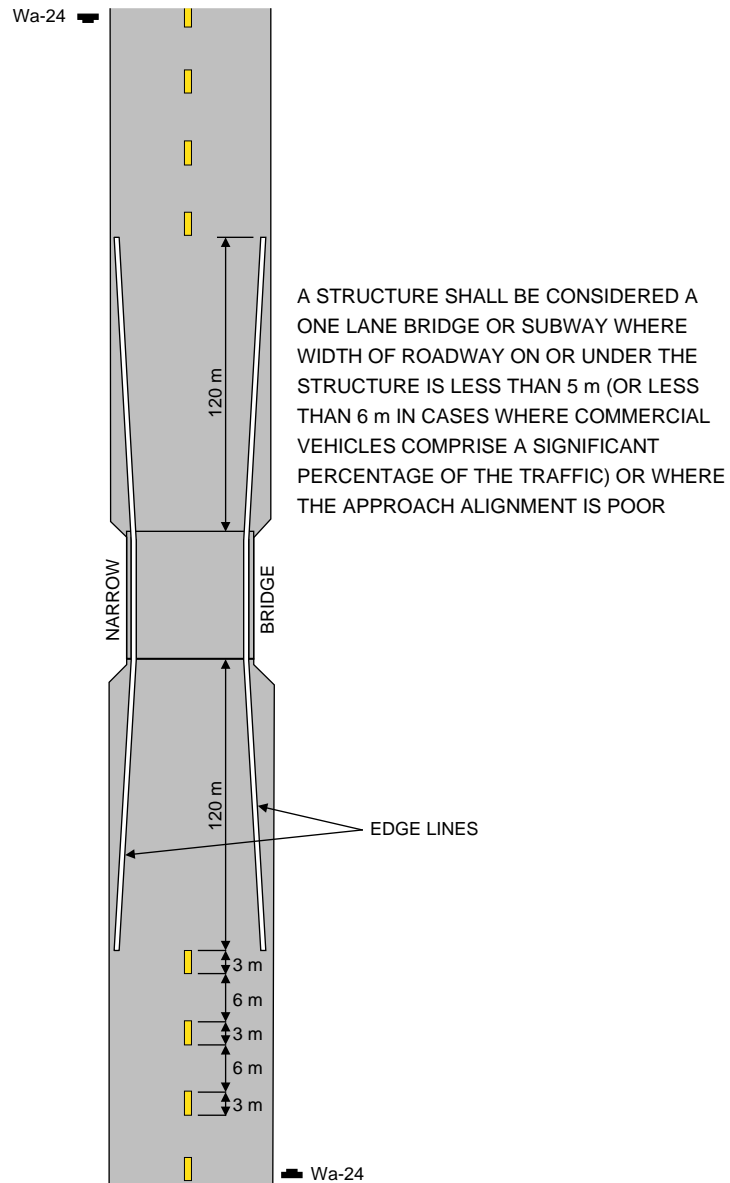
#### *Two-lane Roadways*

Edge lines help drivers to stay on the proper path and reduce the likelihood of a vehicle leaving the designated roadway and losing control on a gravel shoulder or pavement edge drop-off. Where full-width paved shoulders are provided on two-lane roadways, the edge line must be placed to mark an effective lane width of 3.3 m and a paved shoulder width of up to 3 m.

Where the improper use of full-width paved shoulder is to be discouraged (for example, where vehicles illegally pass on the right), the effective shoulder width may be reduced by painting the edge line on the shoulder 15 cm out from the normal edge of the roadway, resulting in an effective lane width of 3.5 m and a paved shoulder width of up to 2.85 m.

Where shoulders are gravel or partially paved, and where pavement drop-off necessitates an abnormal frequency of shoulder grading, an edge line may be placed. Where the pavement width prior to marking provides 3.6 m or more per lane, the edge line must be placed at a distance from the pavement edge so that the lane is consistently 3.3 m wide. The position of the edge line relative to the centre line must not be changed, even if additional pavement has been added along the original edge of the pavement.

Figure 9 – Marking for One-lane Bridge or Subway



Where the lane width prior to marking is less than 3.6 m, the edge line must be placed 15 cm from the shoulder edge of the traveled lane unless the shoulders are partially paved, in which case the edge lines must be placed to provide a marked lane width of 3.3 m.

#### *Interchange Ramps and Channelization Lines*

Edge line and continuity line markings for single-lane on ramps, off ramps, and on-off auxiliary lanes are shown in Figures 10 through 13. These markings must be used at all interchanges. Edge line markings for channelization are shown in Figure 14. On all single interchange ramps and on channelizations, the edge lines must be marked to achieve an effective lane width of 4.2 m.

Edge line markings for multi-lane interchange ramps and channelizations must follow the guidelines for freeway edge line markings.

Figure 10 – Freeway Off Ramps with Wide Lines

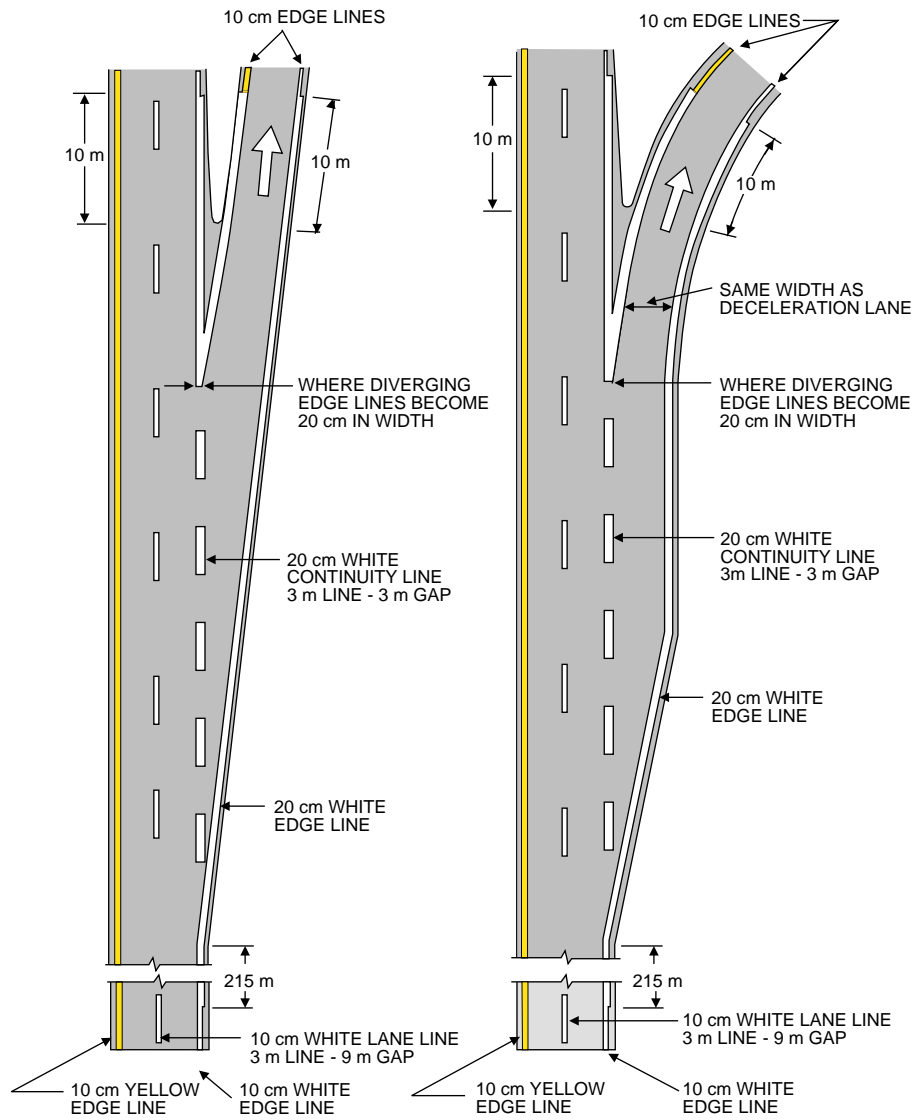


Figure 11 – Freeway On-Off Auxiliary Lane with Wide Lines

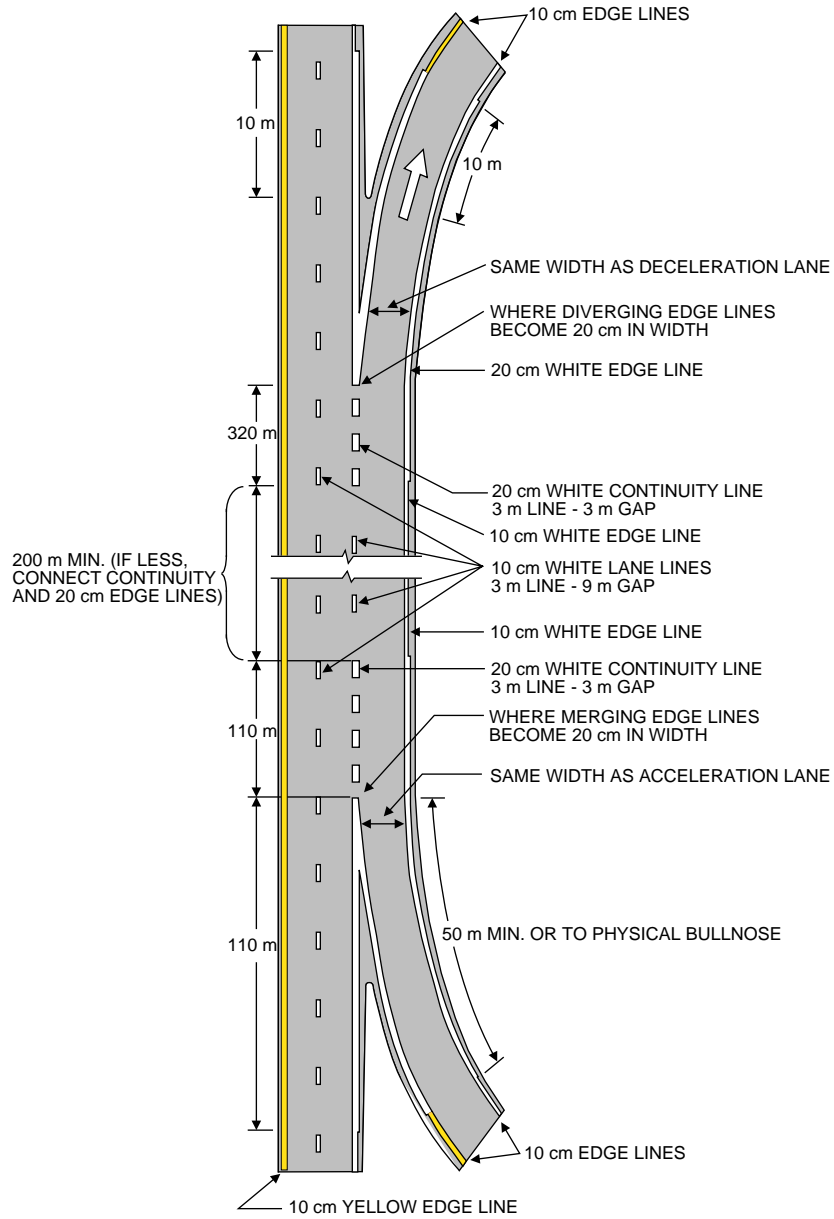


Figure 12 – Freeway Either/or Lane Off Ramps with Wide Lines

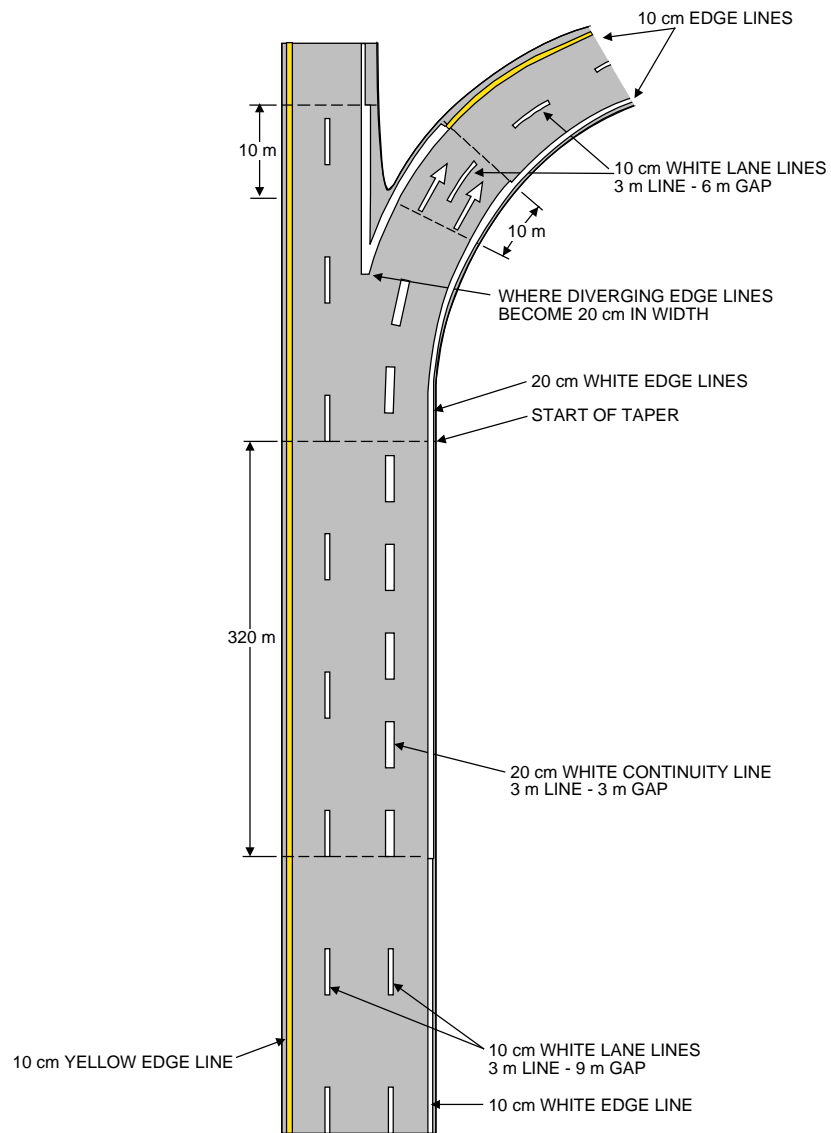
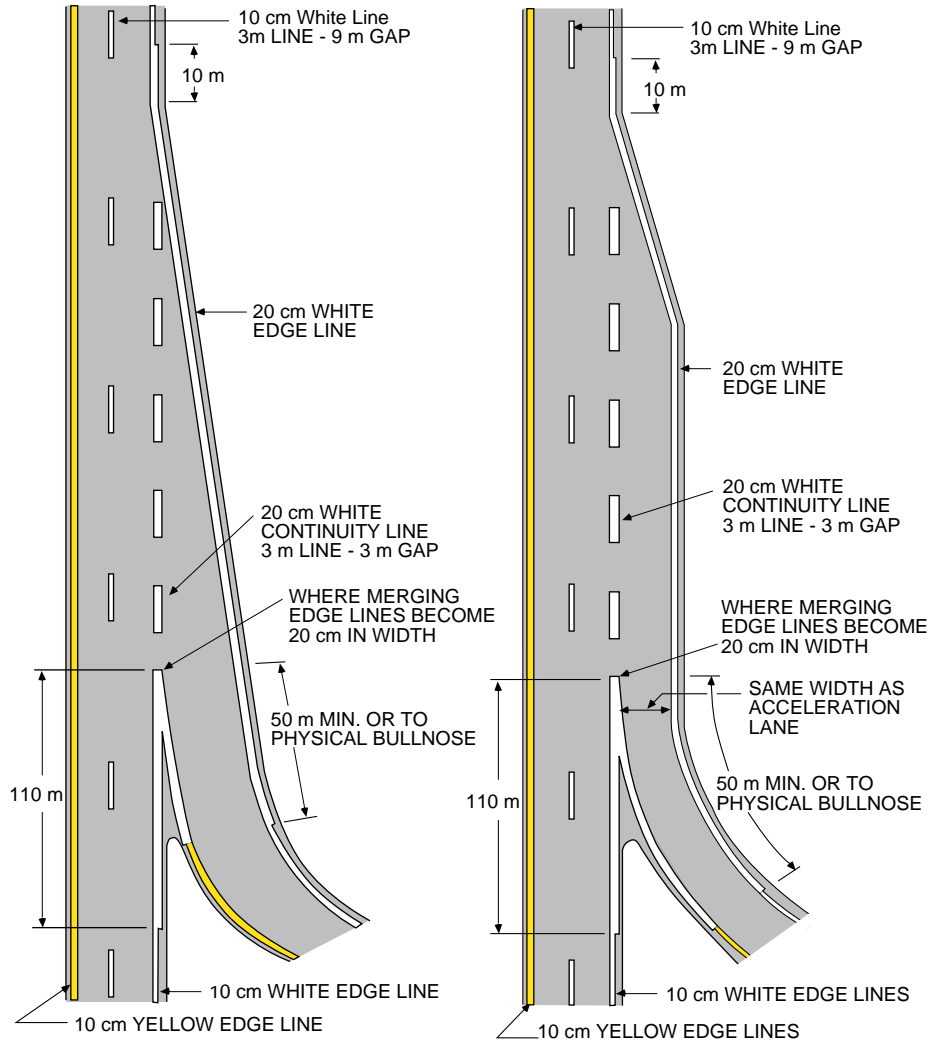
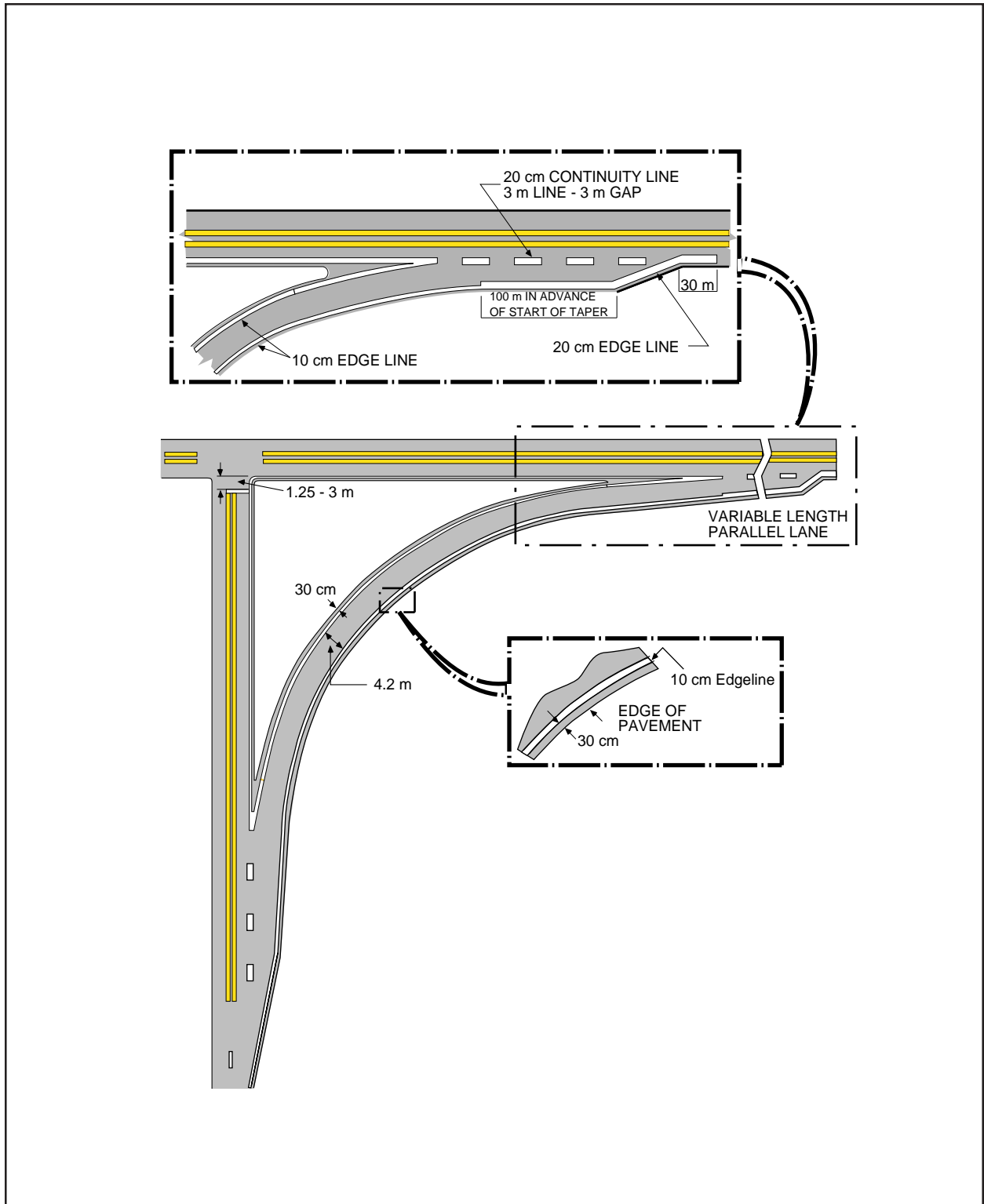




Figure 13 – Freeway On Ramps with Wide Lines





### 3.5 Transition Lines and Continuity Lines

#### Transition Lines

Transition lines are markings which must be used to indicate changes in pavement width such as at offset or terminated lanes, as shown in Figures 15 and 16.

Any reduction in pavement width is an expectancy violation and a hazard to the driver, especially at night. A transition line alone is not sufficient warning of a reduction in pavement width. Pavement width transition lines must only be used to supplement standard warning signs. This helps to prevent driver confusion and error.

Transition lines are subject to the same requirements as lane, edge, and standard directional dividing lines, plus the following:

- Through the transition area, the opposing directions of traffic must be separated by a barrier line in the direction of convergence – either a double solid barrier line, or a broken directional dividing line with an adjacent barrier line;
- When two lanes in the same direction are reduced to one, lane lines must be discontinued 100 m in advance of the start of the taper, and replaced by broken retroreflective continuity lines 20 cm wide for the length of the taper;
- 20 cm edge lines must begin at least 100 m in advance of a taper, and end at least 30 m past the end of the taper in the direction of convergence;
- 10 cm edge lines must begin at least 30 m in advance of a flare (where one lane diverges into two or more lanes), and end at least 30 m past the end of the flare in the direction of divergence.

Converging markings must have a length of not less than L, determined by:

$$L = \frac{S \times W}{1.6}$$

Where: L = length of the transition (metres)  
S = posted speed limit (kilometres per hour)  
W = offset distance (metres)

Longer taper lengths should be used where traffic volumes are high, or where observed 85th percentile speeds exceed posted speed limits.

Longitudinal lines may be supplemented by arrow markings on the pavement, placed before the point at which convergence begins, directing motorists to merge from the discontinued lane into the through lane.

#### Continuity Lines

Continuity lines are wider, more closely spaced lane lines placed to distinguish the edge of a through lane from an adjacent merge or diverge lane. A continuity line reinforces the right-of-way protocol by requiring the motorist who enters or exits the through lane to yield when crossing over it. Continuity lines emphasize signed warning messages normally provided.

Continuity lines must be placed where a merge, diverge, or slow-moving vehicle lane begins or ends adjacent to a through lane:

- On freeways, broken lines approximately 20 cm wide, or twice as wide as the lines in adjacent road sections, should extend along the entire length of a merging or diverging area;

Figure 15 – Transitions from Four to Two Lanes  
(Four Lane to Two Lane Undivided – On Centre Line)

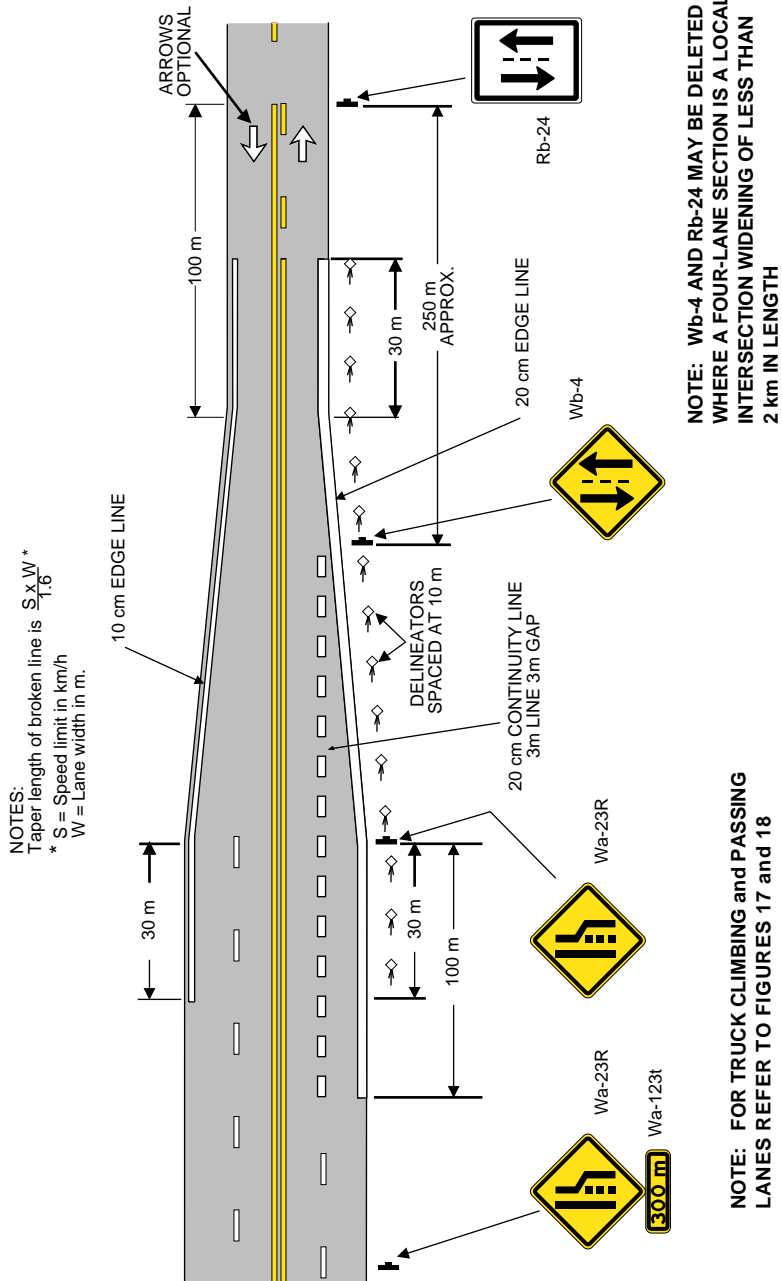
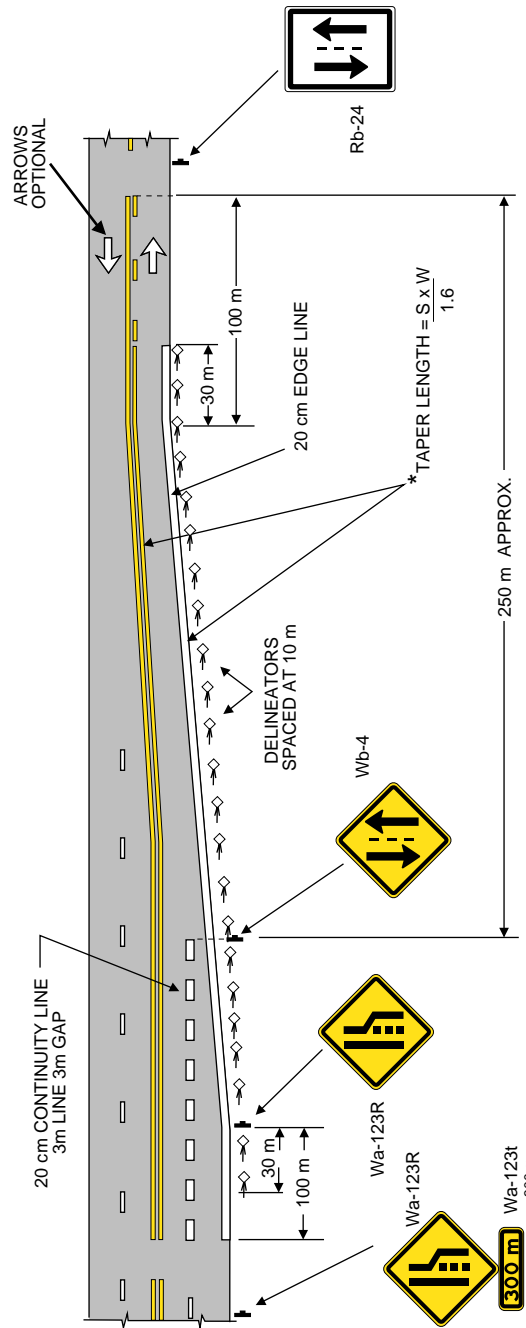


Figure 16 – Transitions from Four to Two Lanes  
(Four Lane to Two Lane – Offset Centre Lines)



**NOTE: Wb-4 AND Rb-24 MAY BE DELETED WHERE A FOUR-LANE SECTION IS A LOCAL INTERSECTION WIDENING OF LESS THAN 2 km IN LENGTH**

\* S = SPEED LIMIT km/h  
W = OFFSET DISTANCE IN METRES

- On lower category roadways, standard continuity lines approximately 10 cm wide may extend along the entire merging or diverging area.

In all cases, the uniform pattern of 3 m segments and 3 m gaps, as shown in Figure 3, must be used.

### 3.6 Interchange Ramps and Channelization Lines

Edge lines and continuity line markings for single-lane on ramps, off ramps, and auxiliary lanes are shown in Figures 10 to 13. These markings must be used at all interchanges. Edge line markings for channelization are shown in Figure 14. These markings assist drivers in choosing and following the correct path without diverting their attention from the roadway. This is of particular importance for inexperienced drivers who have difficulty merging on and off the freeway.

On all single interchanges and channelization, the edge lines must be marked to achieve an effective lane width of 4.2 m.

Edge line markings for multi-lane interchange ramps and channelization must follow the guidelines for freeway edge line markings.

### 3.7 Barrier Lines

#### General

Barrier lines separate opposing traffic streams and denote a no-passing zone on two-way undivided roadways. A barrier line is a solid yellow retroreflective line, 10 cm wide, placed about 10 cm from the directional dividing line. If the directional dividing line is a broken line, the addition of a barrier line results in dual lines (one solid and one broken)

which denote that passing may be attempted in one direction only. The broken line must be placed adjacent to the lane in which passing is permitted, and the solid barrier line must be placed adjacent to the lane in which passing is prohibited. Where the directional dividing line is a solid line, the addition of the barrier line results in a double solid line, denoting that passing is prohibited in both directions.

A no-passing zone may be established where passing would be hazardous (for example, where sight distance is restricted by vertical and/or horizontal curves, at the approach to an intersection, at the approach to an obstruction that must be passed on the right, at lane reduction or transition areas, or in a school zone). A no-passing zone must be marked with a barrier line in addition to a directional dividing line.

Barrier lines must not be broken at private or commercial entrances, but must be discontinued where public roads intersect or where left channelization is present.

#### Lane Reductions

Any reduction in pavement width poses a hazard to drivers, especially at night. Lane reduction markings must be used to guide traffic at points where the pavement narrows, resulting in fewer through lanes. In lane reduction areas, a barrier line must separate the opposing directions of traffic to prohibit passing in the direction of convergence or in both directions. The barrier line helps to define these changes to the driver. Line markings for lane reduction transitions are discussed in Subsection 3.5, "Transition Lines and Continuity Lines".

Figure 17 – Two-lane Highway with Added Truck Climbing Lane

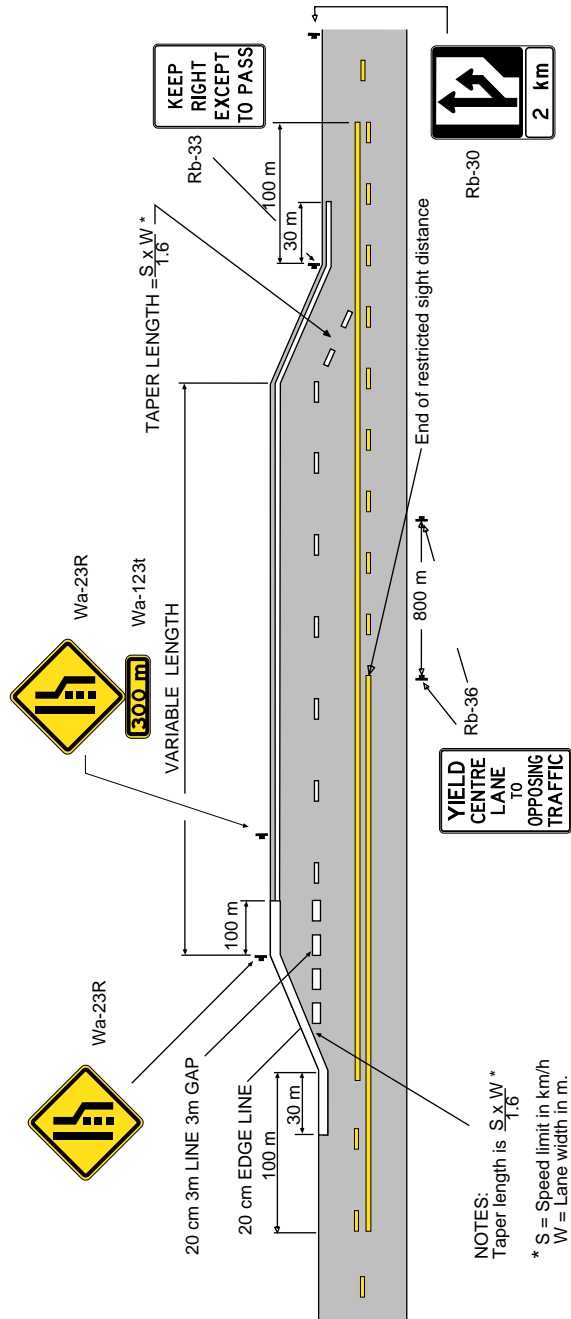
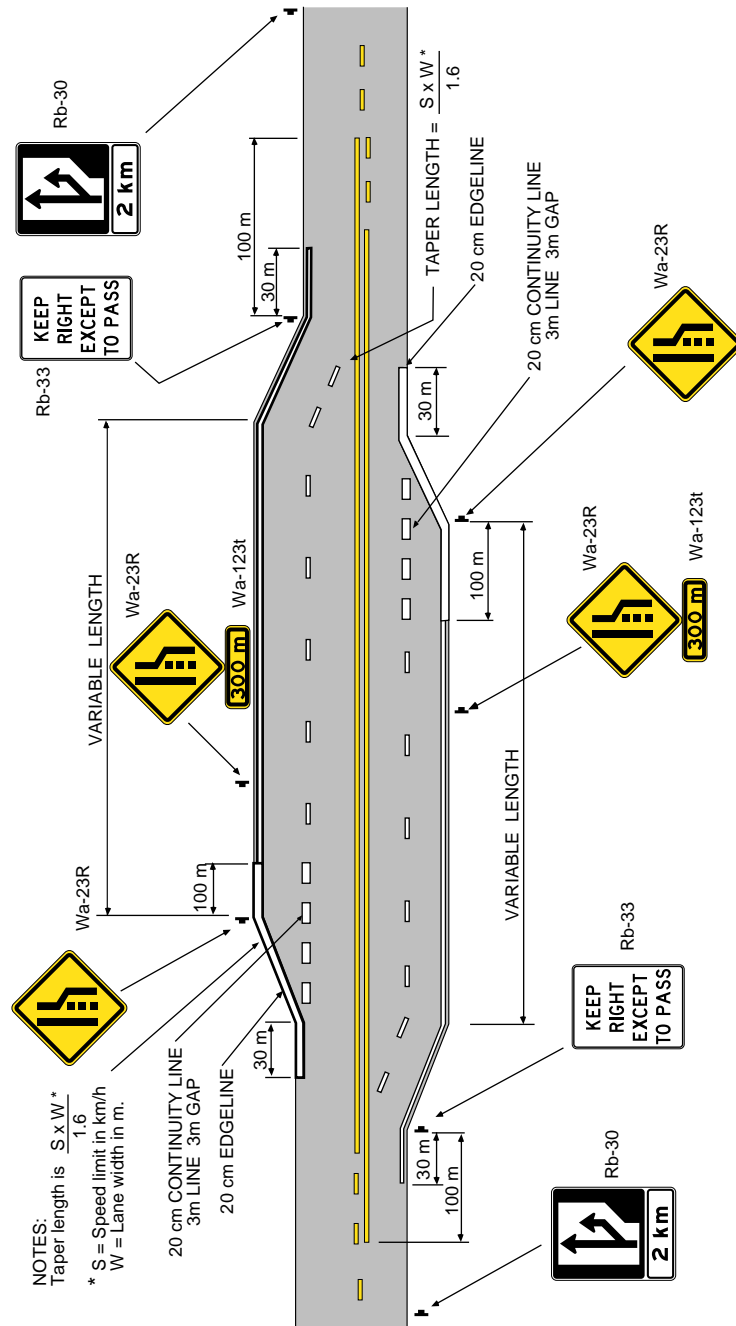


Figure 18 – Two-lane Highway with Added Truck Climbing or Passing Lane





### Passing Zones (Truck Climbing Lanes and Added Passing Lanes)

Figures 17 and 18 show the placement of required regulatory and warning signs and typical guidelines for roadway markings on two-lane highways where a passing lane or truck climbing lane has been added. Post-mounted delineators may be installed to emphasize the lane termination.

### No-passing Zones

#### *Two-lane Roadways*

Where the no-passing zone is in one direction only on a two-way, two-lane roadway a barrier line must be placed adjacent to the lane in which passing is prohibited, while the broken directional dividing line must be carried through the no-passing zone adjacent to the lane in which passing is permitted, as shown in Figure 19.

Where the no-passing zones in opposite directions overlap on a two-way roadway, the solid directional dividing line must be supplemented by a barrier line.

The treatment of directional dividing lines between segments of barrier line is addressed in Figure 20:

- Where two barrier lines would terminate within 25 m of each other without overlapping, they must be extended to meet as shown in Figure 20.
- Where two barrier lines would terminate within 26 m to 80 m of each other without overlapping, the interval between them must be filled by a double broken line as shown in Figure 20.
- Where two barrier lines would terminate more than 80 m apart, the gap between them must be filled by a single broken line as shown in Figure 20.

#### *Criteria for Use*

The establishment of a no-passing zone depends on the speed limit and minimum safe passing sight distance at that speed, which is the minimum view of the highway ahead that a driver needs before attempting to pass another vehicle traveling in the same direction. This distance is based on an assumed driver's eye height of 1.05 m and an object height of 30 cm on the highway ahead (both measured from the pavement surface). A no-passing zone is established where the driver's passing sight distance falls below the minimum.

It is important to remember that passing zone sight distances that are safe for automobiles may be too short for trucks, with their greater height and length and slower acceleration. Passing zones on roads that are heavily traveled by trucks may be established using greater passing sight distances.

Both vertical and horizontal curves require a marked no-passing zone when the sight distance for the speed limit is less than or equal to the minimums listed in Table 1.

**Table 1 – Minimum Passing Sight Distances**

Speed Limit	Minimum Passing Sight Distance
50 km/h	150 m
60 km/h	200 m
70 km/h	250 m
80 km/h	275 m
90 km/h	300 m
100 km/h	380 m
110 km/h	475 m

Figure 19 – Two-lane Pavements

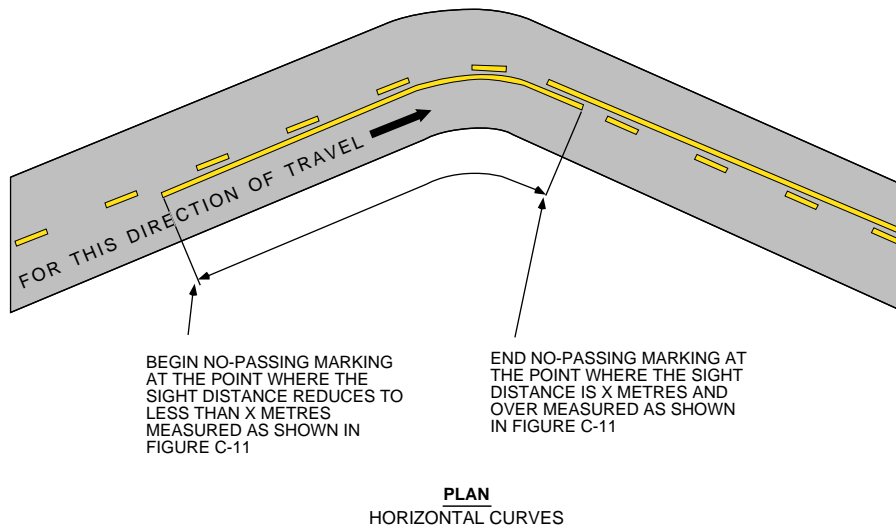
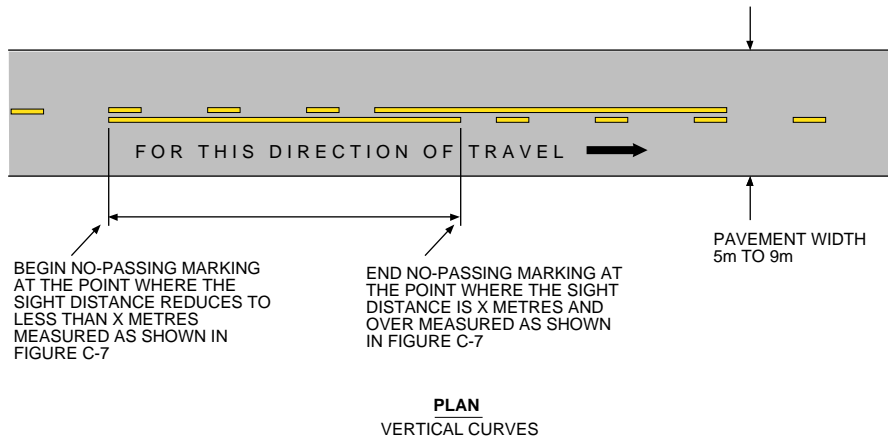
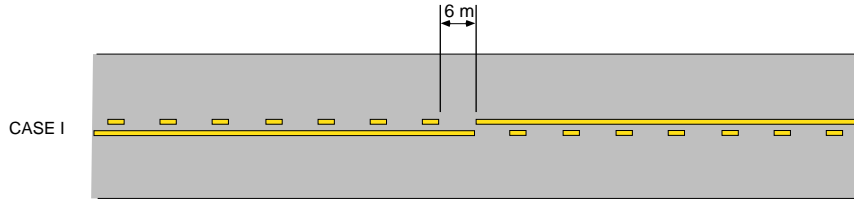
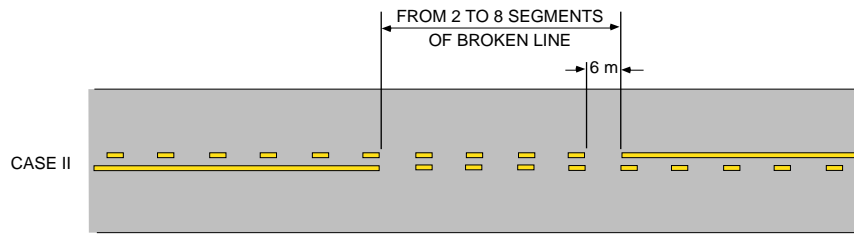


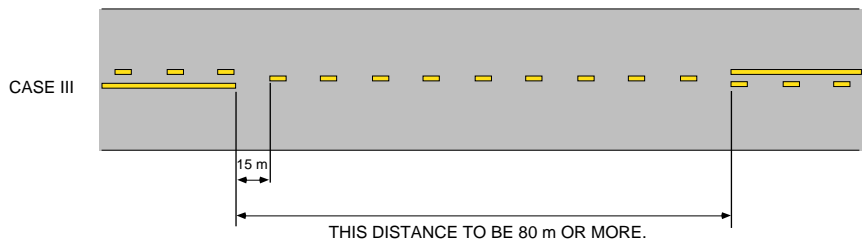
Figure 20 – Treatment of Ends of Barrier Lines on Two-lane Highways



ENDS OF BARRIER LINES WHICH COME WITHIN 25 m OF EACH OTHER SHALL BE EXTENDED TO MEET AS SHOWN.



ENDS OF BARRIER LINES WHICH COME WITHIN 25 TO 80 m OF EACH OTHER SHALL BE ENDED IN LINE WITH THE END OF THE NEAREST SEGMENT OF THE ADJACENT BROKEN LINE AS SHOWN AND A DOUBLE BROKEN LINE SHALL BE USED TO FILL THE GAP.



ENDS OF BARRIER LINES WHICH ARE MORE THAN 80 m APART SHALL BE ENDED IN LINE WITH THE NEAREST SEGMENT OF THE ADJACENT BROKEN LINE AS SHOWN AND A SINGLE BROKEN LINE SHALL BE USED TO FILL THE GAP.

Drivers need a greater distance for safe passing at higher speeds. Where the 85th percentile speed exceeds the speed limit, the minimum safe passing sight distance is increased.

No-passing zones must be used on the approaches to all rural intersections with traffic control signals at intersections where the topography, road alignment, or accident experience dictates the need. The length of the no-passing zone required will depend upon individual intersection characteristics.

It is usually not necessary to mark no-passing zones on urban streets, as speeds are generally low. A single directional dividing line is usually sufficient. On high-speed arterial streets, where no-passing zone markings are required, the guidelines are the same as for rural highways.

No-passing zones must be marked where passing zones are less than the minimum lengths shown in Table 2. These minimums are intended for passing zones on level grades. On appreciable uphill grades, more distance is often required to initiate and complete a safe pass, which makes it desirable to exceed the minimums shown in the table.

**Table 2 – Minimum Lengths of Passing Zones (Level Grade)**

Operating Speed	Minimum Length of Passing Zone
50 km/h	120 m
60 km/h	160 m
70 km/h	200 m
80 km/h	240 m
90 km/h	280 m
100 km/h	320 m
110 km/h	360 m

The methods for locating and setting out barrier lines for vertical and horizontal curves are provided below.

*Vertical Curves*

No-passing zones on vertical curves are determined on the basis of sight distance requirements, as shown in Figure 19. The zones must be established in two steps:

- (1) The proposed zones must be plotted to the nearest multiple of 3 m on a profile of the section of highway, to be marked as shown in Figure 21. The barrier line must be at least 100 m long where the speed limit is less than 60 km/hr, and at least 150 m long where the speed limit is 60 km/hr or more. If the actual no-passing zone is shorter than the specified distance, additional length of barrier line must be added to the beginning of the zone to make up the difference.

Where the distance between the end of one passing zone and the beginning of the next is less than the value in Table 2, the two zones must be joined to form one continuous no-passing zone.

The beginning and end points of each barrier line must be determined from the profile and marked on the pavement during the premarking operation. Any barrier line may be lengthened slightly so that its end is even with the adjacent broken line segment.

- (2) All no-passing zones must be checked at the site using target boards as shown in Figures 22 and 23 before the actual striping operation begins.

Figure 21– Method of Establishing No-passing Zones Using a Highway Profile

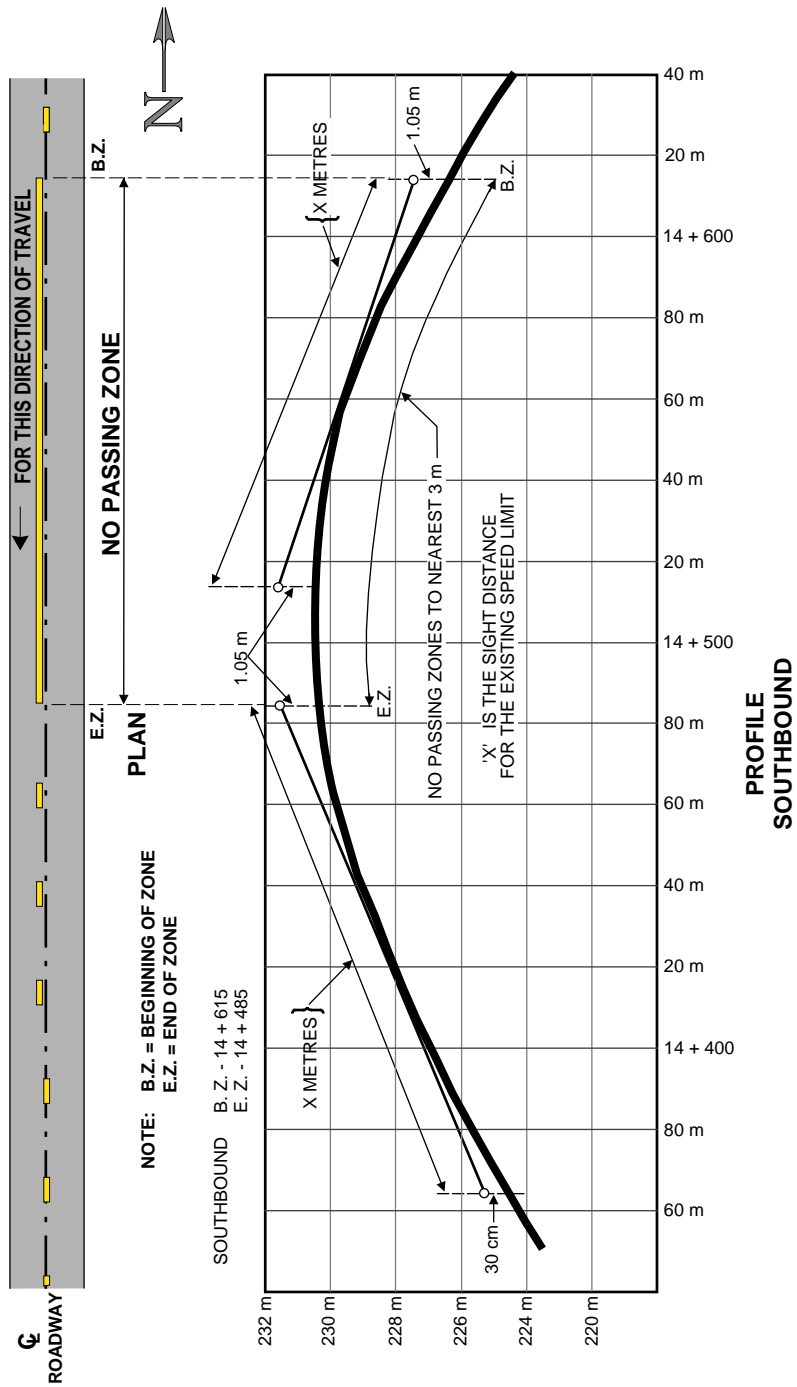


Figure 21– Method of Establishing No-passing Zones Using a Highway Profile (cont'd)

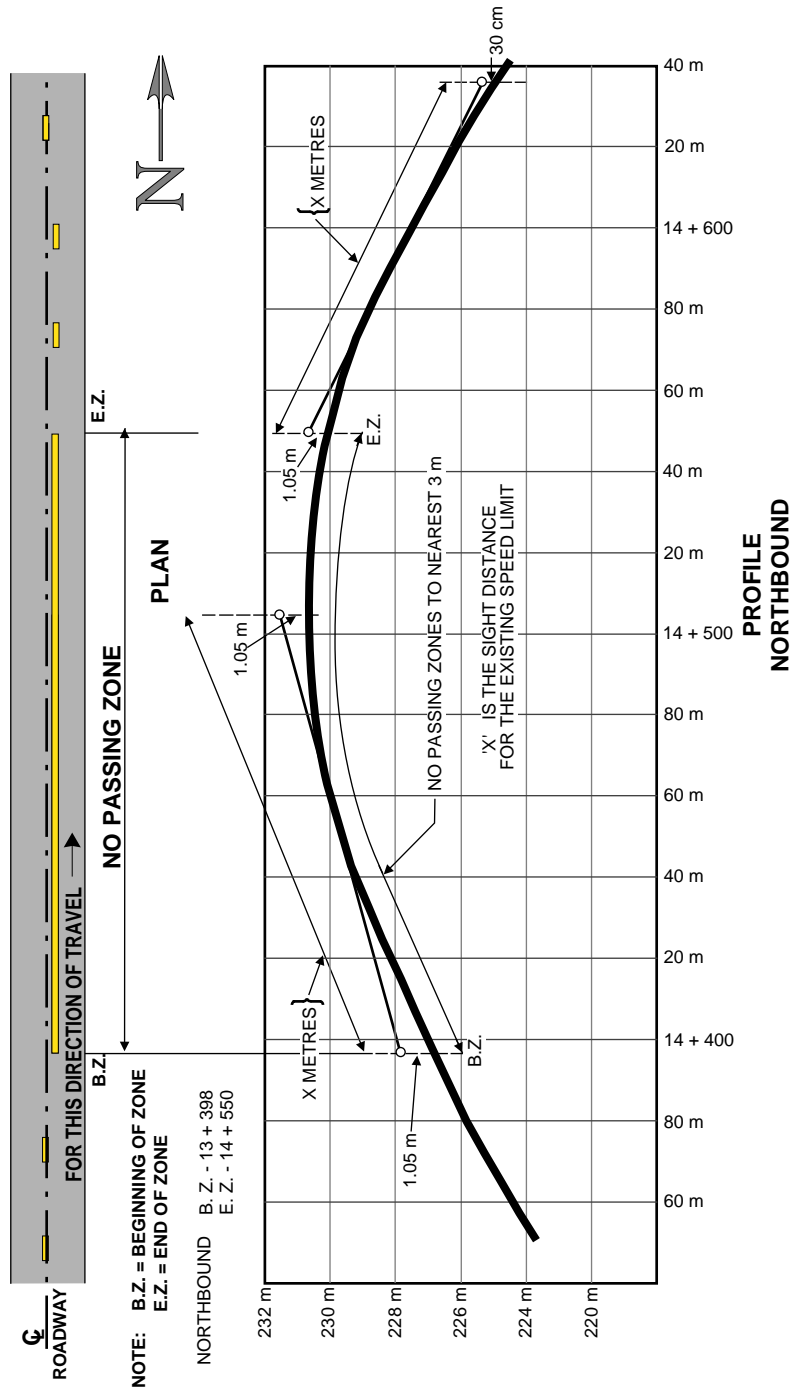
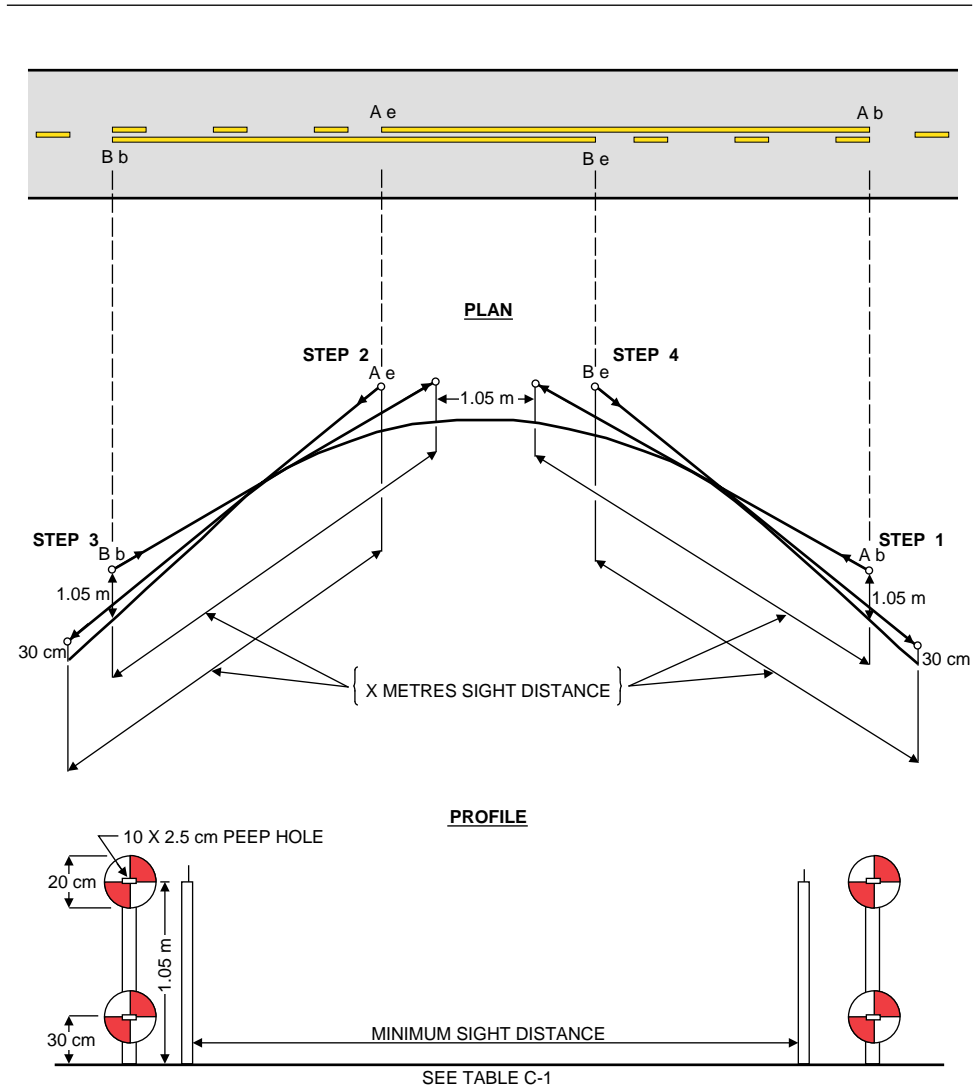


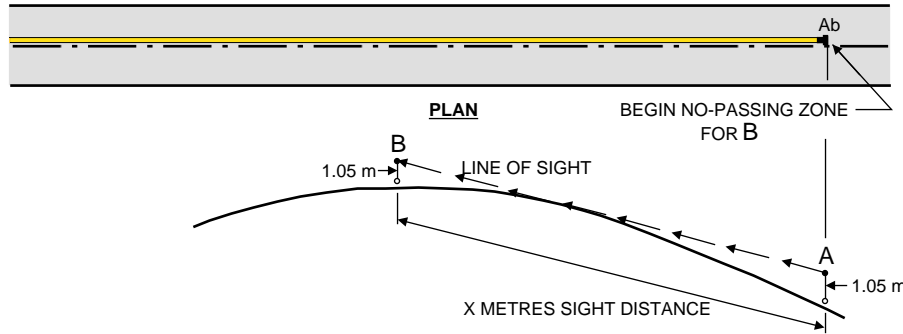
Figure 22 – Sketch Showing the Method of Establishing No-passing Zones on Vertical Curves



The measuring of the x metres sight distance is accomplished with the use of two targets as shown. The peep hole in the target is 10 cm wide and 2.5 cm high. One target is mounted 1.05 m above the pavement and the other 30 cm above the pavement.

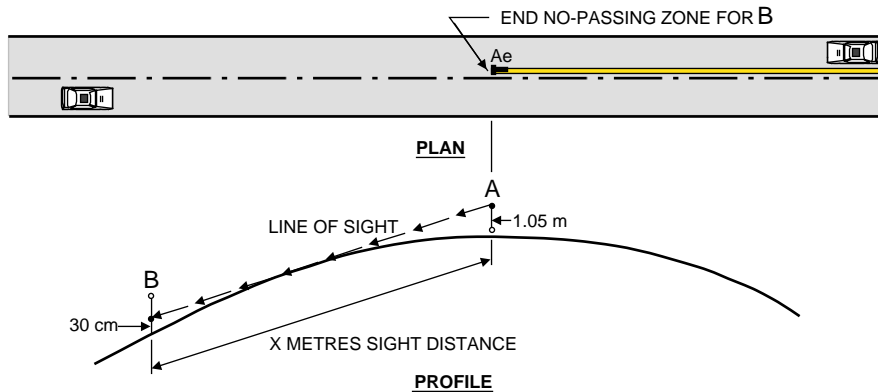
Figure 22 – Sketch Showing the Method of Establishing No-passing Zones on Vertical Curves (cont'd)

STEP 1 { Beginning on the upgrade side of the curve men A and B pull the line taut with A sighting through the slot peephole in his 1.05 m target to see B's 1.05 m target. At the point where B's target just drops out of sight A marks "T" as shown in sketch below.



Note:  
The begin and end marks (T) shall be placed on the pavement so that their stems will point in the direction of the solid line to be applied.

STEP 2 { A and B continue over the vertical curve with A sighting B's lower 30 cm target until it is just visible to A. Place an "end" point to the right of the centre as shown in sketch below.

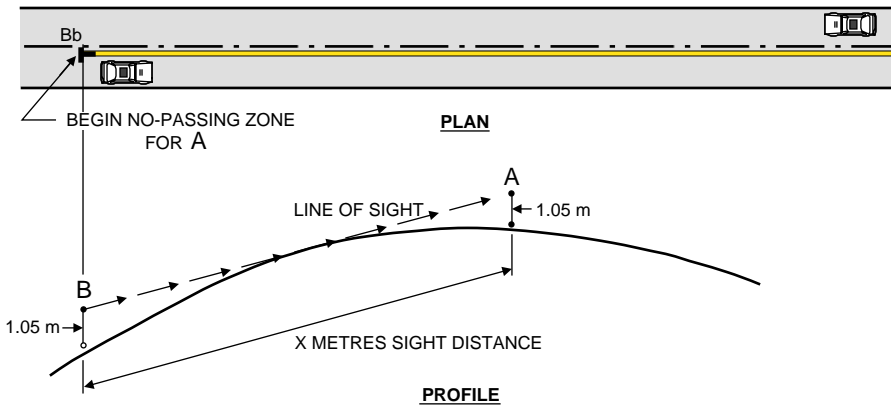


Note:  
The begin and end marks (T) shall be placed on the pavement so that their stems will point in the direction of the solid line to be applied.



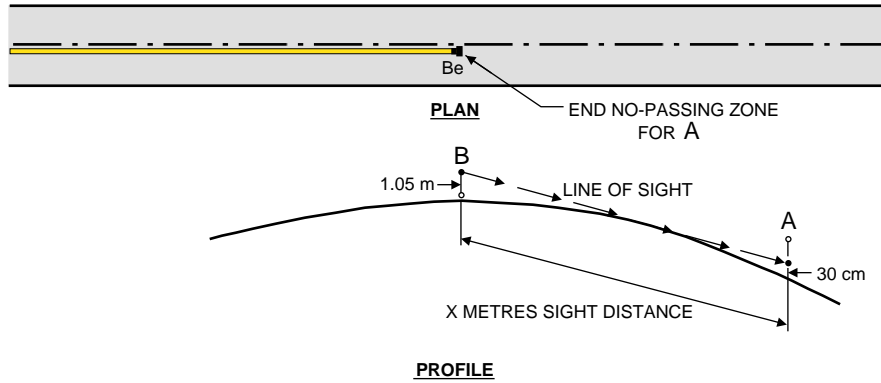
Figure 22 – Sketch Showing the Method of Establishing No-passing Zones on Vertical Curves (cont'd)

STEP 3 { Then both men move back over the vertical curve, holding the line taut and with B sighting from his upper target to where A's upper target just drops out of sight. There B places a 'begin T' as shown in sketch below.



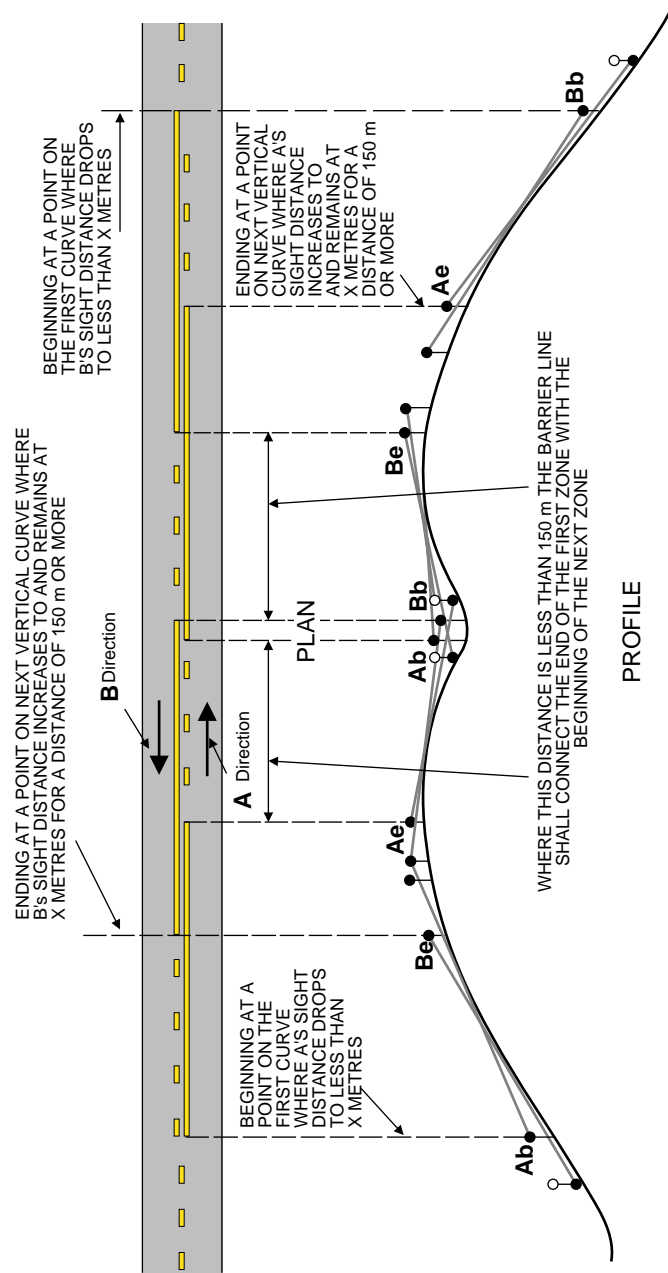
Note:  
The begin and end marks (T) shall be placed on the pavement so that their stems will point in the direction of the solid line to be applied.

STEP 4 { A and B continue over the vertical curve with B sighting A's lower 30 cm target until it is just visible to B. Place an "end" point to the right of the centre as shown in sketch below.



Note:  
The begin and end marks (T) shall be placed on the pavement so that their stems will point in the direction of the solid line to be applied.

Figure 23 – Method of Establishing No-passing Zones for Successive Vertical Curves on Two-lane Pavements



\* SUCCESSIVE HORIZONTAL CURVES ON TWO-LANE PAVEMENTS SHALL BE MARKED SIMILARLY

*Horizontal Curves*

No-passing zones on horizontal curves are determined on the basis of sight distance requirements, as shown in Figures 19 and 24.

Horizontal curves are classified as left curves or right curves, always referenced from the driver's point of view. On any horizontal curve, the highway will curve to the left when viewed from one approach and to the right when viewed from the other. A driver's eye height of 1.05 m and object height of 30 cm must be used in checking passing sight distance.

**(1) Right Curves**

The length of a no-passing zone marked with a barrier line for traffic approaching a right curve must be established using Table 3 or by measuring the sight distance in the field as shown in Figure 24. A barrier line must be marked from the beginning of curve (BC) to the end of curve (EC) on all curves that generate a Zone A value in Table 3.

For circular curves, BC is the point where the roadway centreline departs from tangent and EC is the point where the roadway centreline returns to tangent.

Where a spiral curve has been used between the tangent and circular curves, points BC or EC must be assumed to be at the midpoint of the spiral for the purpose of marking a right curve. Table 3 provides values for Zone A, the length of barrier line to be provided in advance of a right curve. Where no value for Zone A is given, no barrier line is used on the right curve.

**(2) Left Curves**

The length of no-passing zone marked with a barrier line for traffic approaching a left curve must be established by measuring the sight distance in the field, as shown in Figure 24. Where barrier line "B" required on a left curve, measured as shown in Figure 24, is shorter than 100 m, it must be extended beyond the beginning of the curve by adding the Zone "C" value, so the  $B + C = 100$  m. Where the distance is over 100 m, it must be marked as measured.

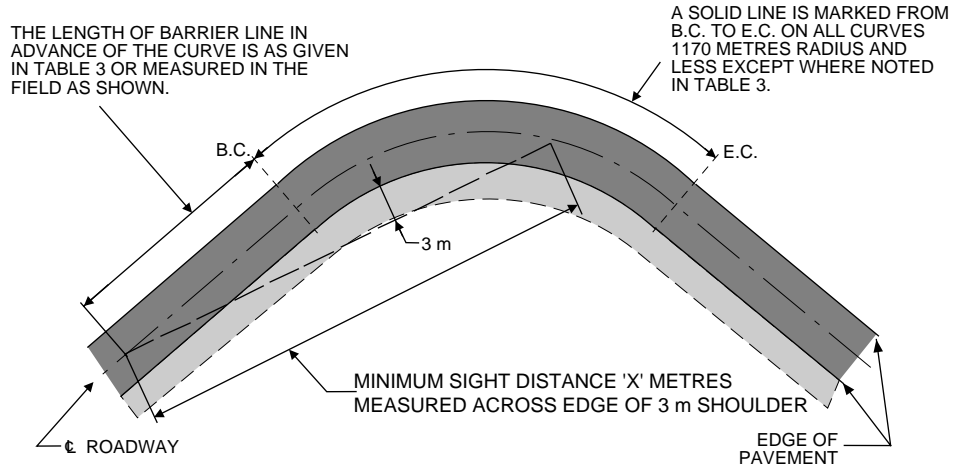
For a right curve the sight distance is measured as tangent to the edge of a theoretical 3 m shoulder. For a left curve, the line of sight may cross the right-of-way on the inside of a curve, provided that there are no trees, rock embankments, poles, buildings, or other obstructions between the line of sight and the highway.

A lateral offset of 1.5 m should be maintained between the line of sight and all foliage to allow for future growth of trees and bushes. The line of sight may pass as close as practicable to any poles, buildings, or rocks.

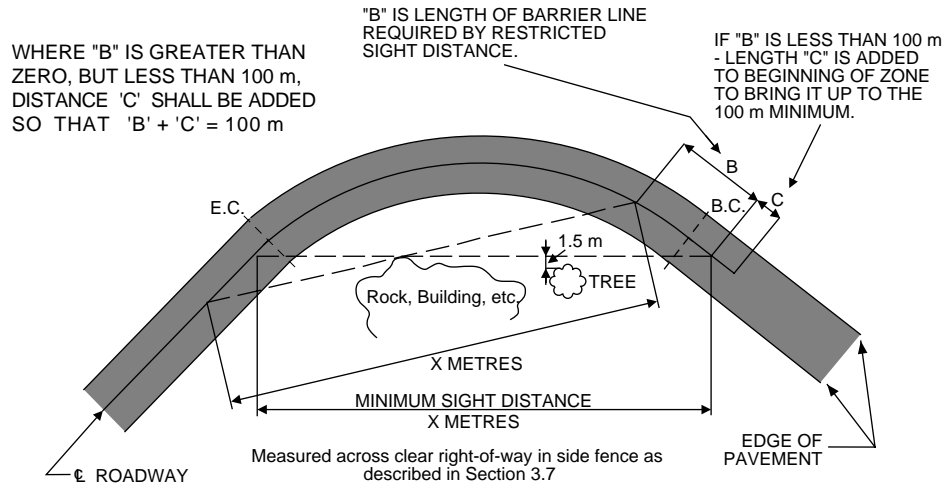
The line of sight may cross the fence line where the highway curves left around a lake or on a high fill where the line of sight cannot be obstructed by future building construction, growth of trees, or fields of crops.

Approval should be obtained from the road authority prior to conducting sight distance measurements outside the roadway fence lines or across private property.

Figure 24 – Method of Establishing No-passing Zones on Horizontal Curves



Plan showing method of marking barrier line on RIGHT curve (showing one direction only)



Plan showing method of marking barrier line on LEFT curve (showing one direction only)

Table 3 – Length of Barrier Line in Advance of Right Curve (in metres)

Speed Limit (km/h)		50	60	70	80	90	100	110
Degree of Curvature	Radius (m)	Zone "A" (Length of barrier line in advance of right curve in metres)						
1°	1750	-	-	-	-	-	-	-
1°30'	1170	-	-	-	30	100	145	190
2°	875	-	-	30	75	130	175	220
2°30'	760	-	30	75	100	145	190	220
3°	580	-	55	90	130	165	200	230
3°30'	500	30	65	100	140	175	210	230
4°	440	45	80	110	155	180	220	240
4°30'	390	55	90	120	155	190	220	240
5°	350	65	100	130	165	200	230	245
5°30'	320	65	100	130	165	200	230	245
6°	290	75	110	140	175	210	240	245
6°30'	270	75	110	140	175	210	240	255
7°	250	80	120	140	180	210	245	255
7°30'	230	80	120	145	180	220	245	255
8°	220	90	130	145	190	220	245	255
8°30'	205	90	130	155	190	220	255	255
9°	195	90	130	155	190	220	255	265
9°30'	180	90	130	155	190	220	255	265
10°	175	90	130	155	190	220	255	265
10°30'	165	90	130	160	190	220	255	265
11°	160	100	130	165	200	230	265	265
11°30' & over	150 or less	100	140	165	200	230	265	275

Where no value for Zone "A" is given, no barrier line shall be used on the right curve.

## Narrow Bridges

A no-passing zone must be established over all bridges, within all subways, and under structures where the clearance between the edge of approach pavement and rail, pier, or abutment is 60 cm or less on one or both sides of the roadway. The narrowing of lanes represents an expectancy violation and a hazard to drivers. The configuration of the bridge may also pose a hazard (for example, loss of the shoulder or narrowing of the lanes). Pavement markings and signs alert drivers and guide them to the safest position to cross.

- (1) On two-lane roadways with lanes at least 4 m wide on or under a structure, the no-passing zone must be marked by a double barrier line and by a barrier line or lines extending back 120 m on each approach. The purpose of this is to prohibit passing for traffic approaching or (if appropriate) for traffic leaving the structure. This is shown for two-lane bridges in Figure 25.
- (2) Where the approach pavement is less than 7 m wide, a single barrier line must be applied rather than a double barrier line.
- (3) On two-lane roadways with lanes more than 2.5 m wide (3 m where the proportion of large commercial vehicles is significant) and less than 4 m wide on or under a structure, the no-passing zone must be marked by a single barrier line extending 120 m from the structure in both directions. Such a structure will be marked with a standard Wa-24 (Wa-124) Narrow Structure sign.
- (4) Any roadway having theoretical lane widths on or under a structure less than those specified in (3) is to be classed as a one-lane bridge and marked with the approach markings illustrated in Figure 9.

## Approach Markings for Obstructions

If traffic is required to pass to the right of an obstruction, a barrier line must be marked on the approach to the obstruction to prevent two-way passing. The minimum length of the barrier line must be calculated using the following equation:

$$L = 1.24 (W \cdot S) \quad \text{for speed limits of 70 km/hr or greater}$$

$$L = 0.013 (W \cdot S^2) \quad \text{for speed limits of 60 km/hr or less}$$

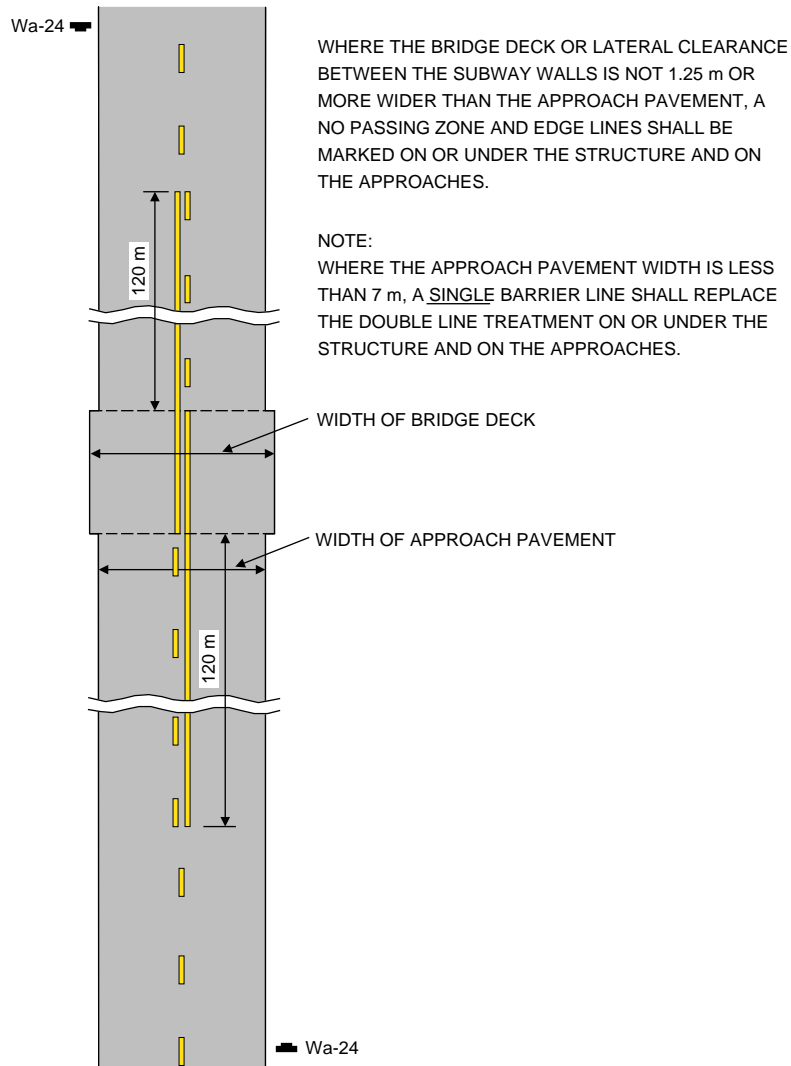
Where: L = minimum length of barrier line (metres)

W = width of the offset distance (metres)

S = posted speed limit (km/hr)

Where observed 85th percentile speeds exceed the posted speed limit, a longer barrier line approach may be marked.

Figure 25 – Marking for Narrow Bridge or Subway



### 3.8 Intersections

Markings are used at intersections to reduce vehicle and pedestrian conflicts, improve the capacity of the intersection, and clarify information used in driver decision-making.

No-passing zones should be used on the approaches to all major intersections and at other intersections where the topography or road alignment makes it necessary. The length of the no-passing zone will depend upon individual intersection characteristics such as approach speed and geometry.

These markings will alert drivers that they are approaching an intersection and give them adequate time to respond. Intersection markings can also help drivers understand a transitory condition hazard such as a line of traffic stopped beyond the crest of a vertical curve.

#### Controlled Intersections

##### *STOP Signs*

Typical approach markings for rural intersections controlled with STOP signs are shown in Figures 26 through 30. These markings may be supplemented by the word STOP placed on the pavement on the approach in compliance with the guidelines in Section 3.12 of this Book.

At urban intersections with standard STOP line and crosswalk markings, the lane lines and directional dividing line must end at the STOP line on the approach side of the intersection. Typical approach markings for urban intersections controlled with STOP signs are shown in Figure 31.

At both urban and rural intersections, a stop line (also called a stop bar) must be used to indicate the point at which a vehicle must stop in compliance with the STOP sign. A stop line must be a solid white retroreflective line between 30 cm and 60 cm wide. The stop line must extend across the approach lanes from the right pavement edge to the directional dividing line or median, or, in the case of one-way streets, to the left pavement edge. Typical examples of stop line application are shown in Figures 26 to 31 inclusive.

Where there is no pedestrian crosswalk, the stop line must be located between 1.25 m and 3 m upstream of the projected nearside edge of the intersecting road. At STOP signs where visibility is restricted, the stop line should be located so that the driver of a vehicle properly positioned behind the stop line has an adequate view of approaching cross traffic in both directions. The stop line should also be positioned with reference to the clearance needs of cross traffic and pedestrians. At intersections where a crosswalk is located, the separation between the crosswalk line and the stop line must be 1 m, as shown in Figures 32 and 33, except where special circumstances dictate otherwise.

A stop line is normally placed parallel to the edge of the crossing roadway and parallel to crosswalk lines. At a skewed intersection with a pedestrian crosswalk, the stop bar should be placed perpendicular to the curb.

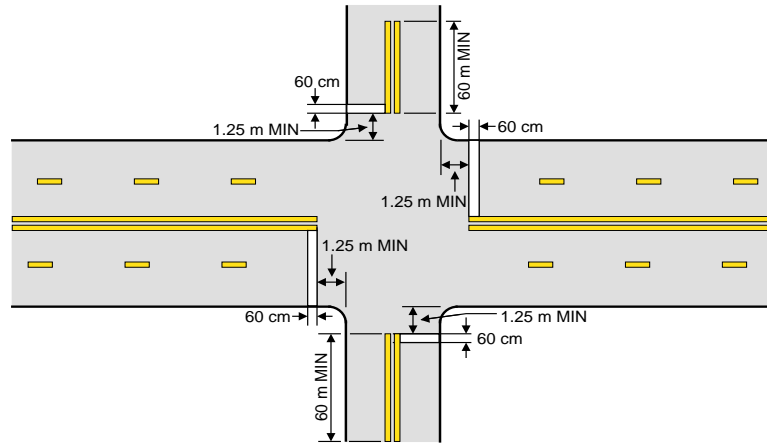
Stop lines may be omitted on the paved aprons of gravel road intersections with highways.

##### *Traffic Control Devices*

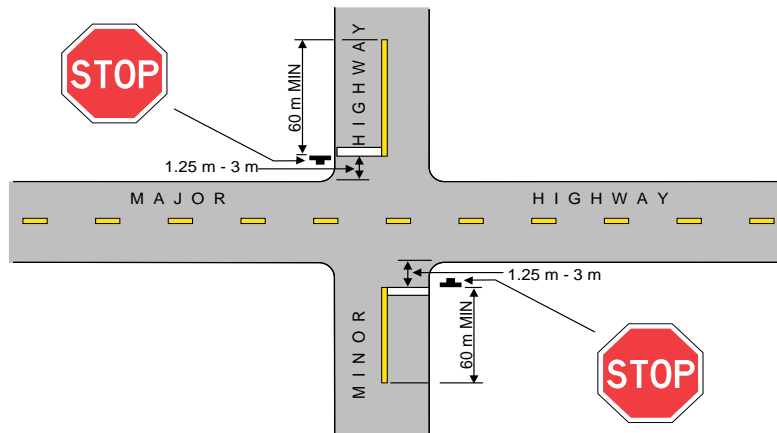
Typical approach markings for rural signalized intersections are shown in Figure 26. Typical approach markings for urban signalized intersections are shown in Figures 32 and 33.



Figure 26 – Approaches to Rural Intersections



SIGNALIZED INTERSECTION



UNSIGNALIZED INTERSECTION

Figure 27 – Marking for Right-turn Lane

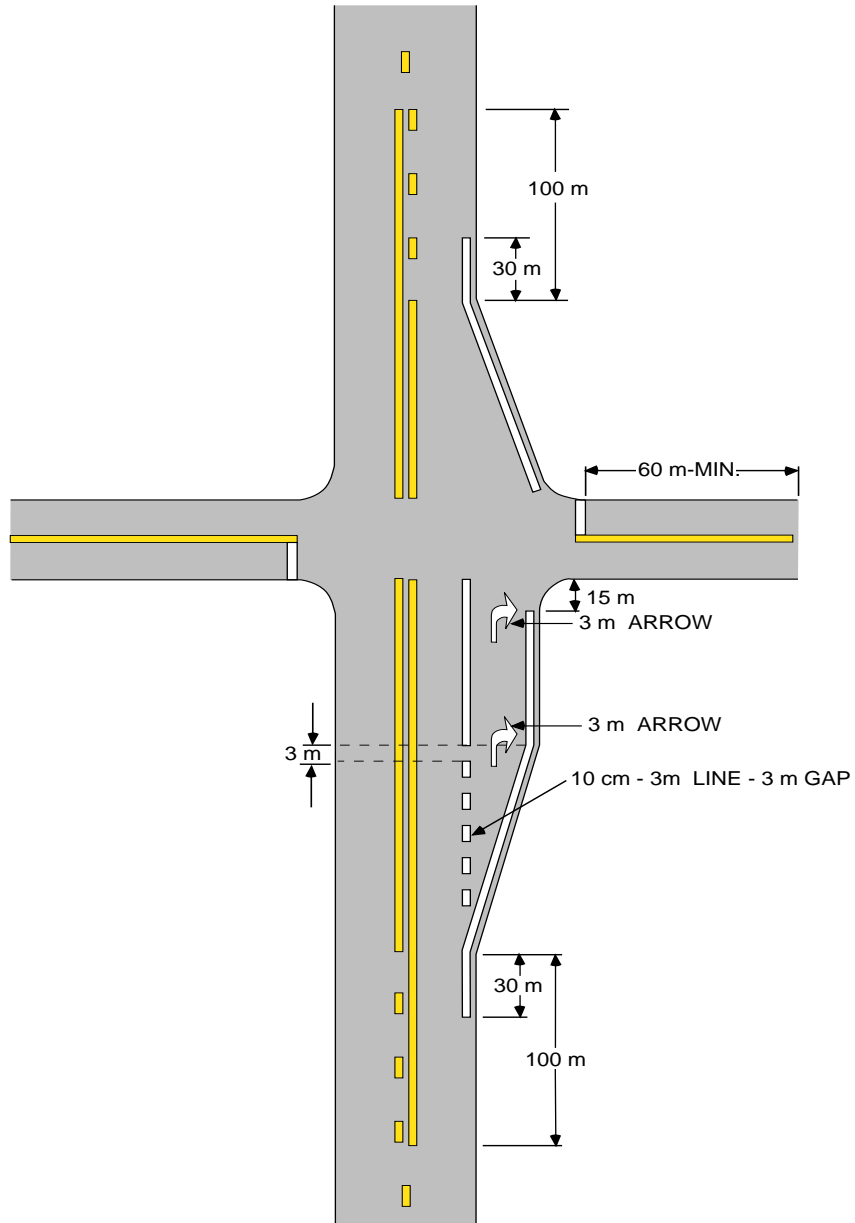


Figure 28 – Marking for Right-turn Taper

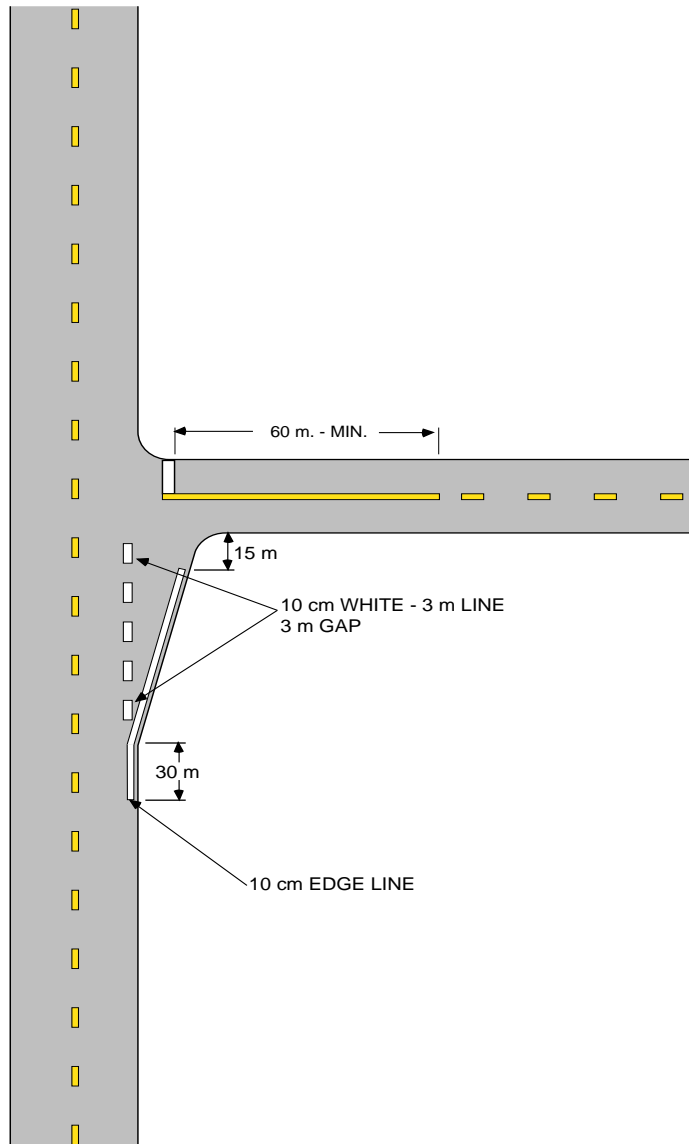


Figure 29 – Separate Left-turn Lane

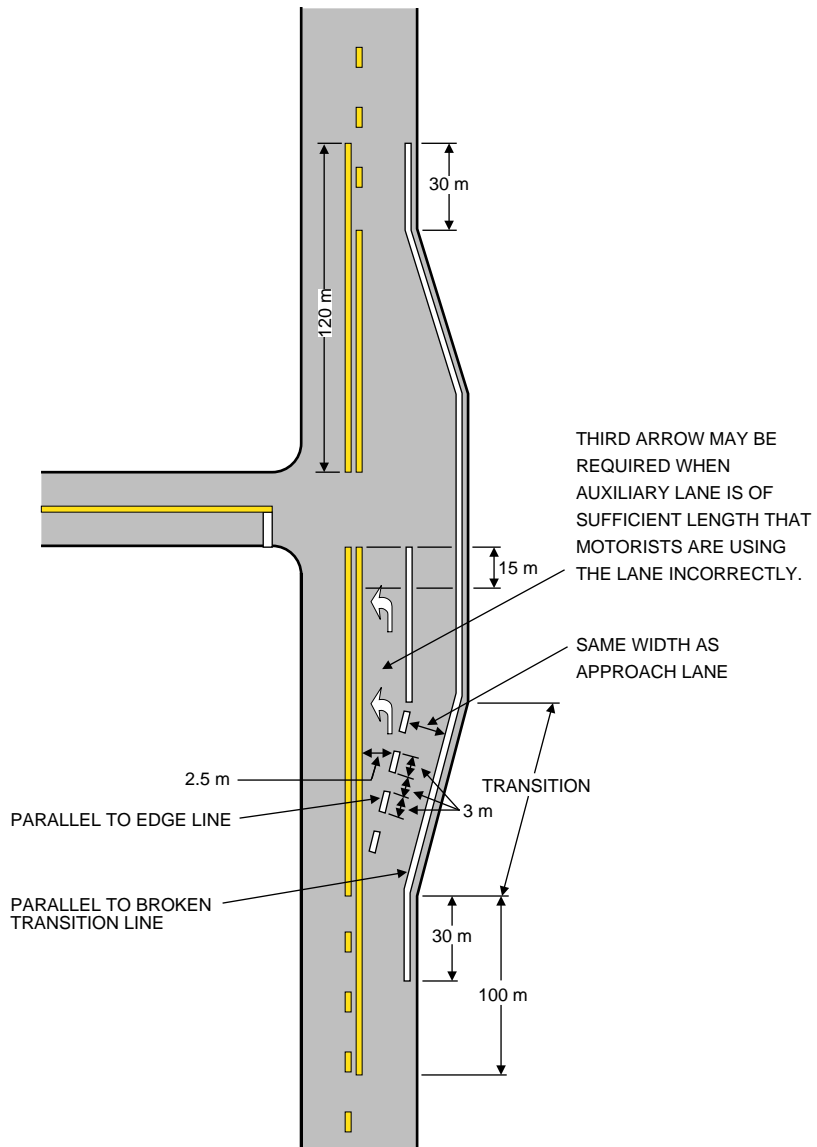


Figure 30 – Left-turn Slip-around

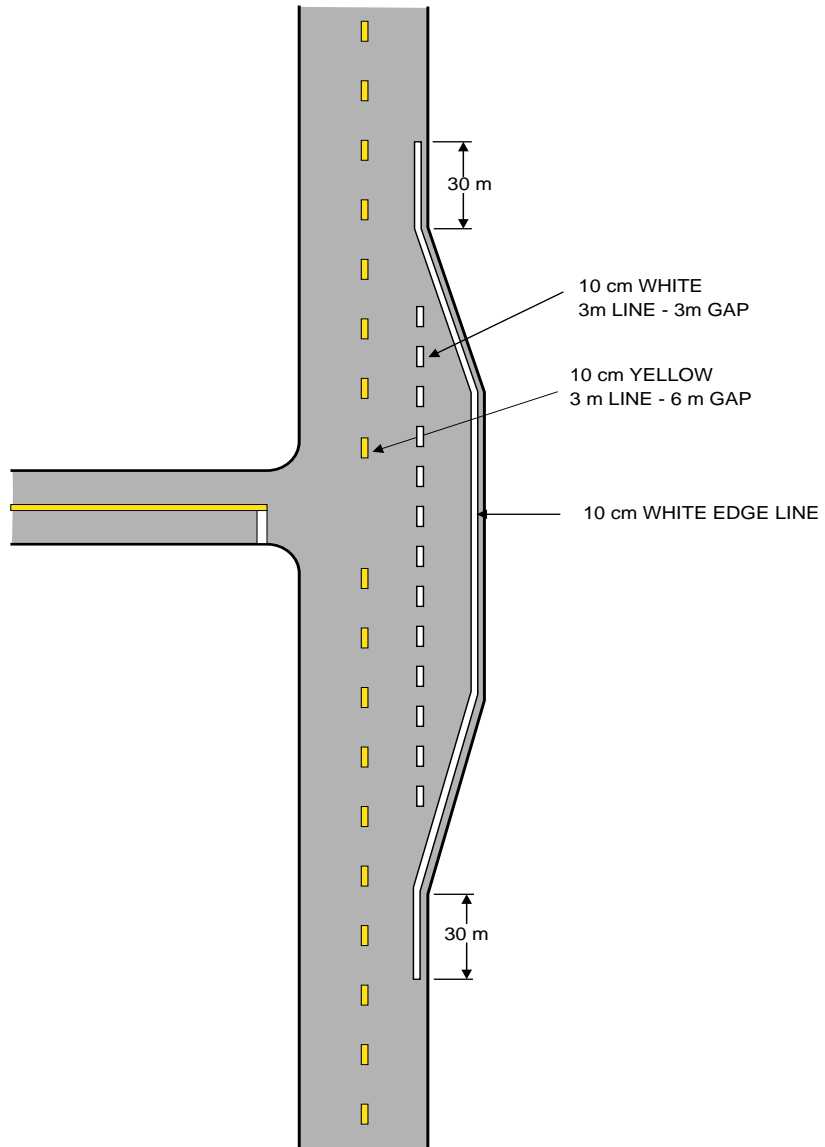


Figure 31 – Approaches to Unsignalized Urban Intersections

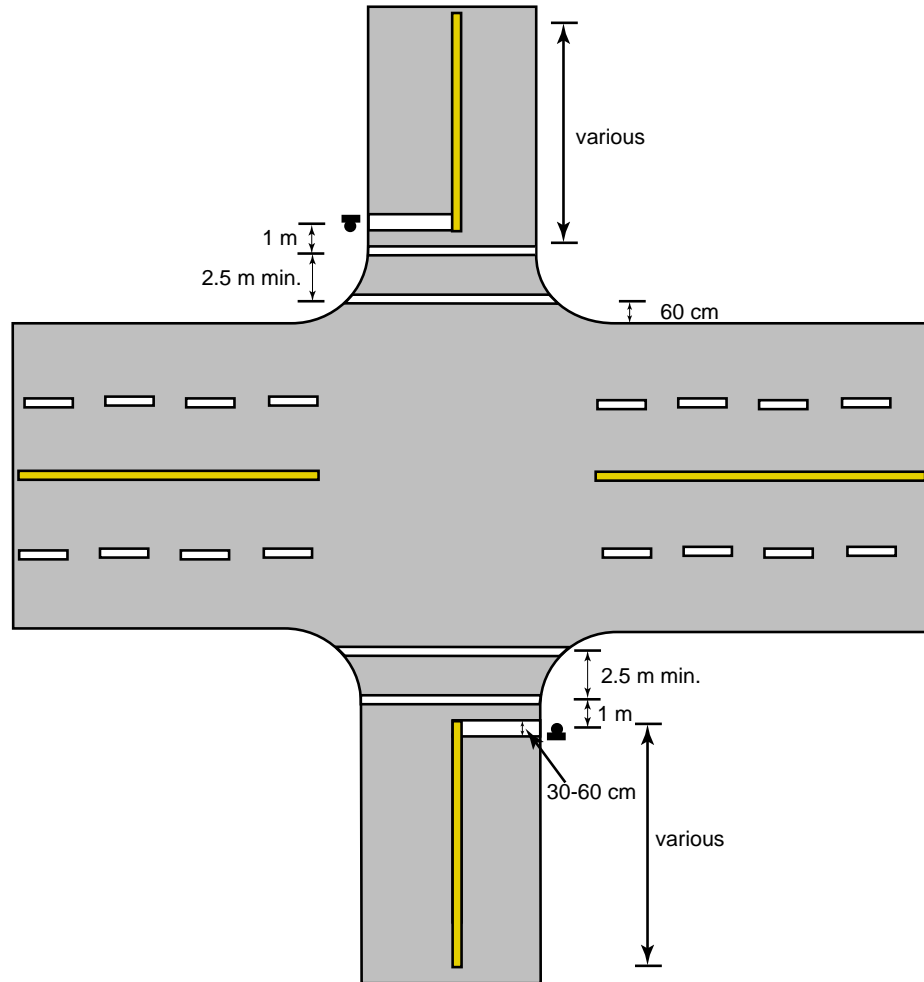


Figure 32 – Signalized Intersection

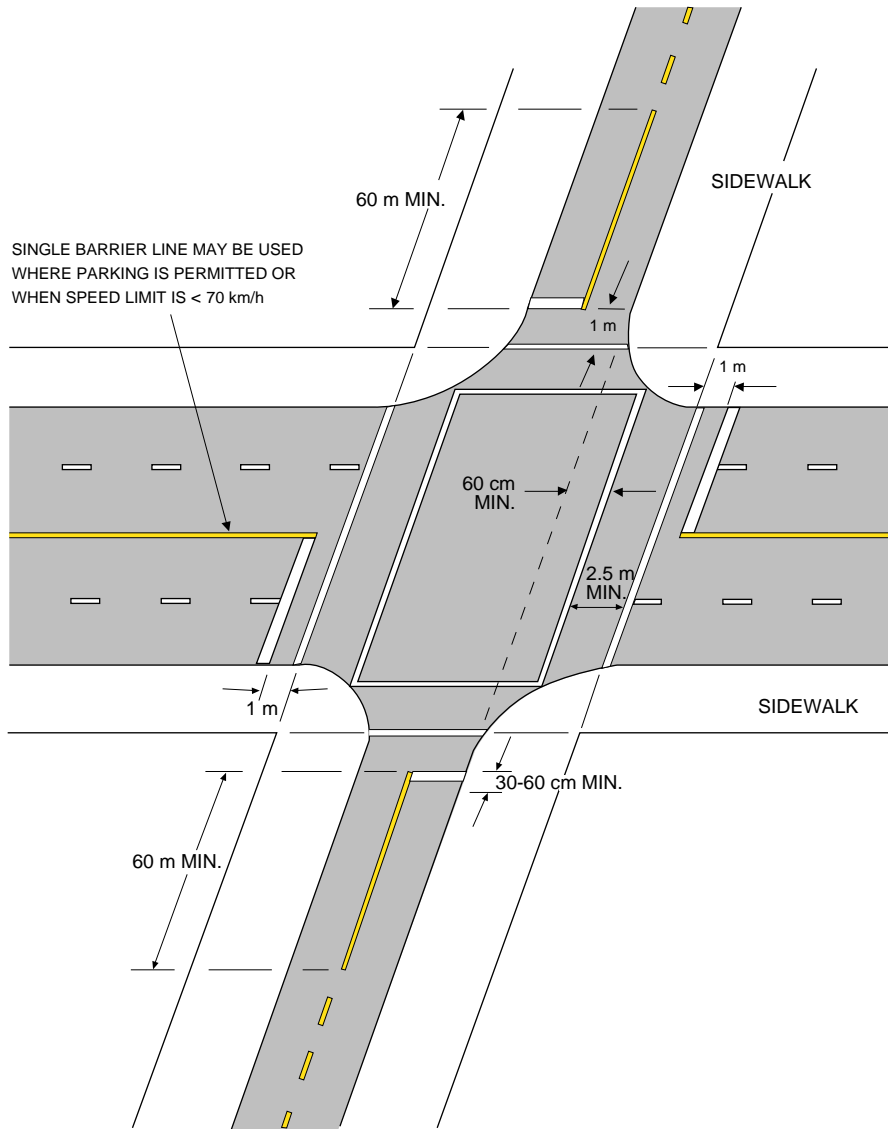
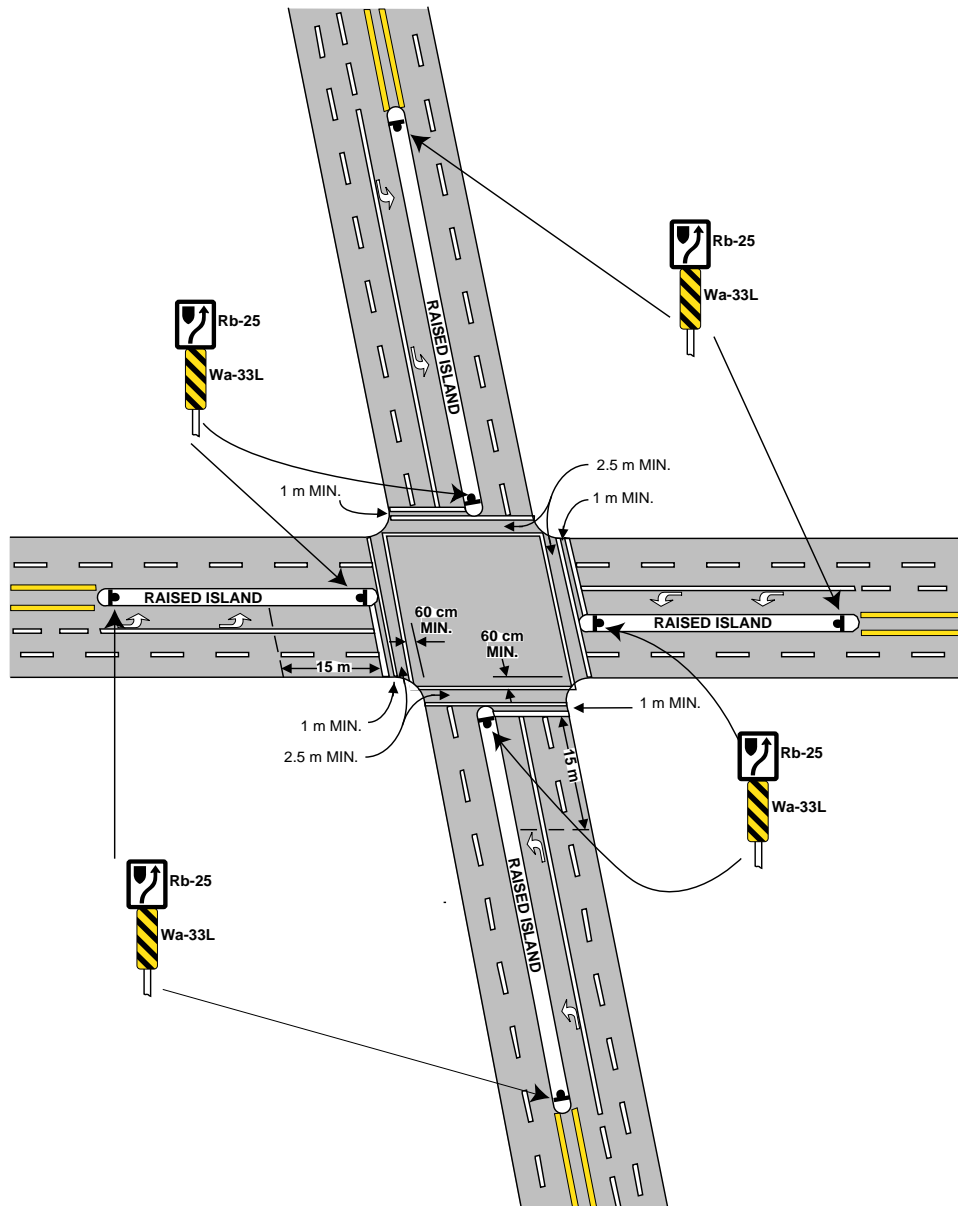


Figure 33 – Location of “Keep Right” Sign at Signalized Urban Intersection





A stop line must be used to indicate the point at which a vehicle must stop in compliance with the traffic signal. A stop line must be a solid white retroreflective line between 30 cm and 60 cm wide. The stop line must extend across the approach lanes from the right pavement edge to the directional dividing line or median, or, in the case of one-way streets, to the left pavement edge. Typical examples of stop line application are shown in Figures 26, 32 and 33. Stop lines are normally placed parallel to the edge of the crossing roadway, but may be positioned at an angle to the edges of crossing roadways when those roadways are of different widths, as shown in Figure 31.

Where there is no pedestrian crosswalk, the stop line must be located between 1.25 m and 3 m upstream of the projected nearside edge of the intersecting road. At intersections where a crosswalk is located, the separation between the crosswalk line and the stop line must be 1 m as shown in Figures 32 and 33, except where special circumstances dictate otherwise. Stop lines should be parallel to crosswalk lines.

#### *Guide Lines*

Guide lines are used to guide vehicles through an intersection or interchange where the legs are offset, skewed, or have a complex configuration, or where more than one lane for a single turning movement exists. The guide lines delineate the proper course to be taken by vehicles traversing the intersection or interchange and help to prevent driver confusion.

Guide lines should be condensed broken white retroreflective lines 20 cm wide, composed of 1 m segments with 1 m gaps as shown in Figure 3.

#### *Crosswalks*

Crosswalk markings define and delineate the path for pedestrians to cross the roadway. In rural areas, crosswalks should be marked at signalized intersections where pedestrians normally use the signal to cross the highway. Crosswalks should be marked at all intersections where there is substantial conflict between vehicle and pedestrian movements.

Crosswalk lines must be solid white parallel retroreflective lines 10 cm to 20 cm wide, extending entirely across the pavement, as shown in Figures 32 and 33. Under special circumstances, such as where vehicle stop lines are not provided or where vehicle speeds exceed 60 km/hr, the crosswalk lines may be widened to 60 cm. The downstream edge of the crosswalk should be inset at least 60 cm from the projected nearside curb line of the cross street.

The width of the crosswalk between the lines is usually determined by the widths of the connected sidewalks and the expected two-way pedestrian flows utilizing the crossing at the peak time. The crosswalk must be at least 2.5 m wide. The 1985 U.S. Highway Capacity Manual (Transportation Research Board Special Report 209) outlines a procedure to calculate the crosswalk widths required for high pedestrian volumes. Widths of 3 m to 4 m are typical of urban areas with significant pedestrian activity.

Obstacles such as curbs and raised islands should remain outside the crosswalk lines in consideration of persons with walking impairments and persons using wheelchairs, walkers, and strollers. The traveled part of the crosswalk must be aligned with sidewalk ramps and curb cuts where these are provided at one or both sides of the roadway.

Pedestrian crossovers and school crossings are discussed in Section 3.9.

## Turn Lanes

Exclusive left-turn and right-turn lanes can increase intersection capacity, improve intersection operation, and reduce the incidence of rear-end collisions. To realize these benefits, exclusive turn lanes must be properly designed, so that left-turn lanes provide adequate storage space and right-turn lanes make adequate provision for cyclists traveling through the intersection.

Where separate turning lanes have been provided, it is desirable to separate through traffic from turning traffic by means of channelizing pavement markings. Typical markings for right-turn channelization and tapers are shown in Figures 27 and 28, for separate right-turn channelization in Figure 14, and for separate left-turn lanes in Figure 29. These lines are particularly useful to drivers faced with dense traffic or complex manoeuvring areas.

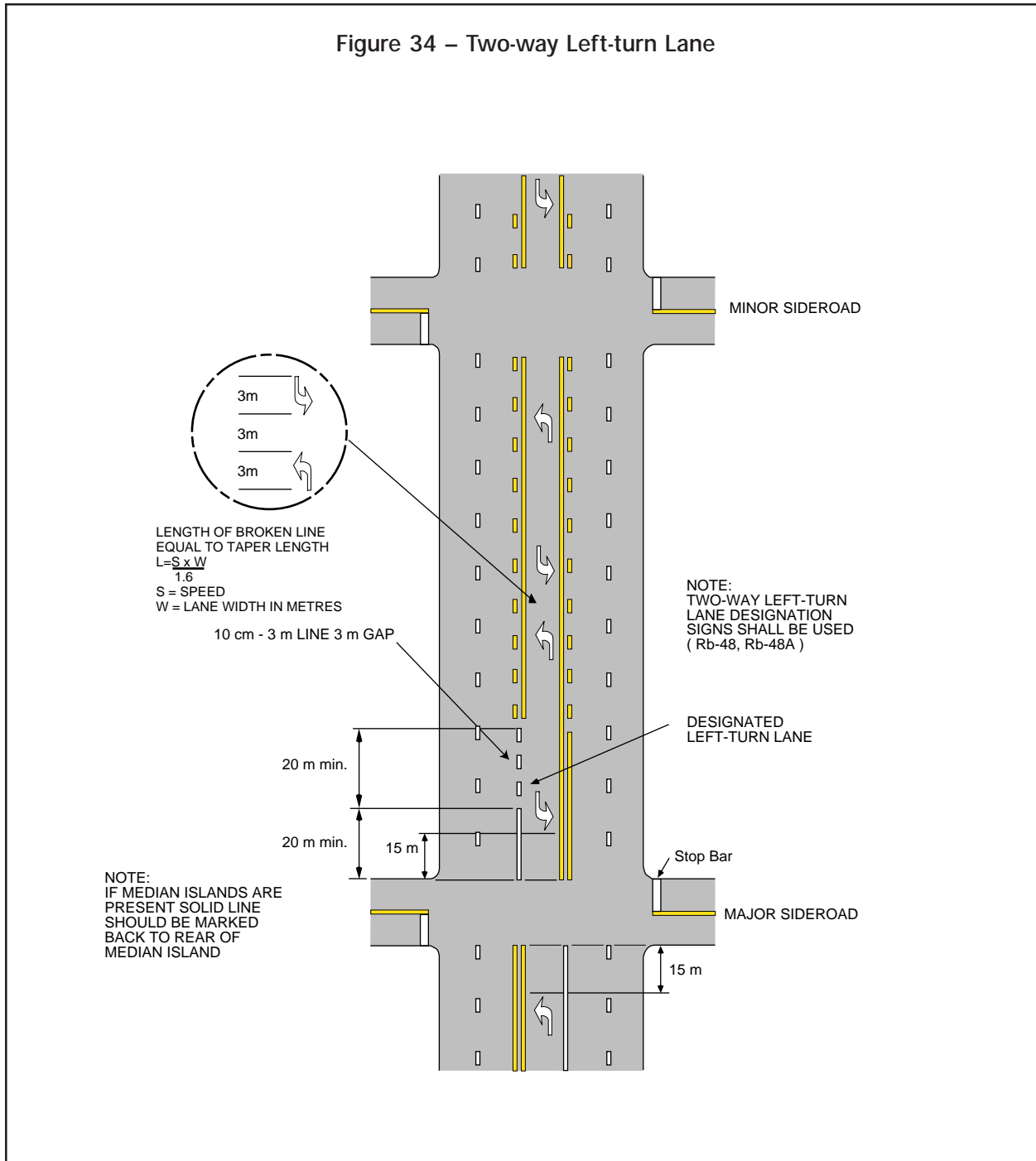
At unsignalized T-intersections where through vehicles frequently attempt to bypass slowed or stopped vehicles waiting to turn left, provided that an adequate paved shoulder exists, a left-turn slip-

around lane (also called a shoulder bypass lane) may be added by re-marking the highway edge line as shown in Figure 30. A slip-around lane may also be introduced to reduce collisions or improve traffic operations. A left-turn slip-around lane should be introduced only if a left-turn storage lane is not possible.

When a left-turn or right-turn lane is of sufficient length that a motorist could unintentionally drive into the auxiliary lane, arrows might be required to indicate that vehicles in the auxiliary lane are required to turn. Arrows as shown in Figures 27 and 29 should be located such that they will ensure that the motorist understands the intended use of the auxiliary lane and is deterred from making erratic manoeuvres such as last minute lane changes close to the intersection.

When a two-way left-turn lane is used on a section of roadway, it should be marked as shown in Figure 34.

Figure 34 – Two-way Left-turn Lane



## Traffic Calming Devices

Traffic calming refers to measures taken to control vehicle access and speed in areas where high flows and speeds are undesirable or unsafe. Traffic calming is typically used to make residential streets less attractive to short-cut and non-local through traffic by controlling the speed and routing of traffic.

Measures used to achieve traffic calming include:

- Traffic circles;
- Median barriers to block left turns;
- Barriers (traversable or non-traversable) to partly or fully block entry into roads;
- Conversion of intersections into cul-de-sacs;
- Introduction of midblock cul-de-sacs;
- Pavement undulations (including speed bumps and raised pavement plateaus);
- Raised intersections;
- Rumble strips;
- The use of “chokers”, where the roadway is narrowed at an intersection;
- All-way STOPs;
- Posting of reduced speed limits;
- Introduction of one-way street signage;
- Street closure.

Details concerning the implementation and delineation of traffic calming measures can be found in the *Canadian Guide to Neighbourhood Traffic Calming* (TAC, 1998).

## 3.9 Reserved Facility Markings

### Transit and High Occupancy Vehicles

#### *Clearance and Vehicle Guidance*

Pavement markings are sometimes helpful to indicate the limits and clearance of the overhang on turning streetcars or transit vehicles, particularly trolley coaches. Such guide lines can assist both transit and non-transit drivers.

Clearance lines must be broken white retroreflective lines, 10 cm wide, with segments and gaps of equal length, each not exceeding 1 m.

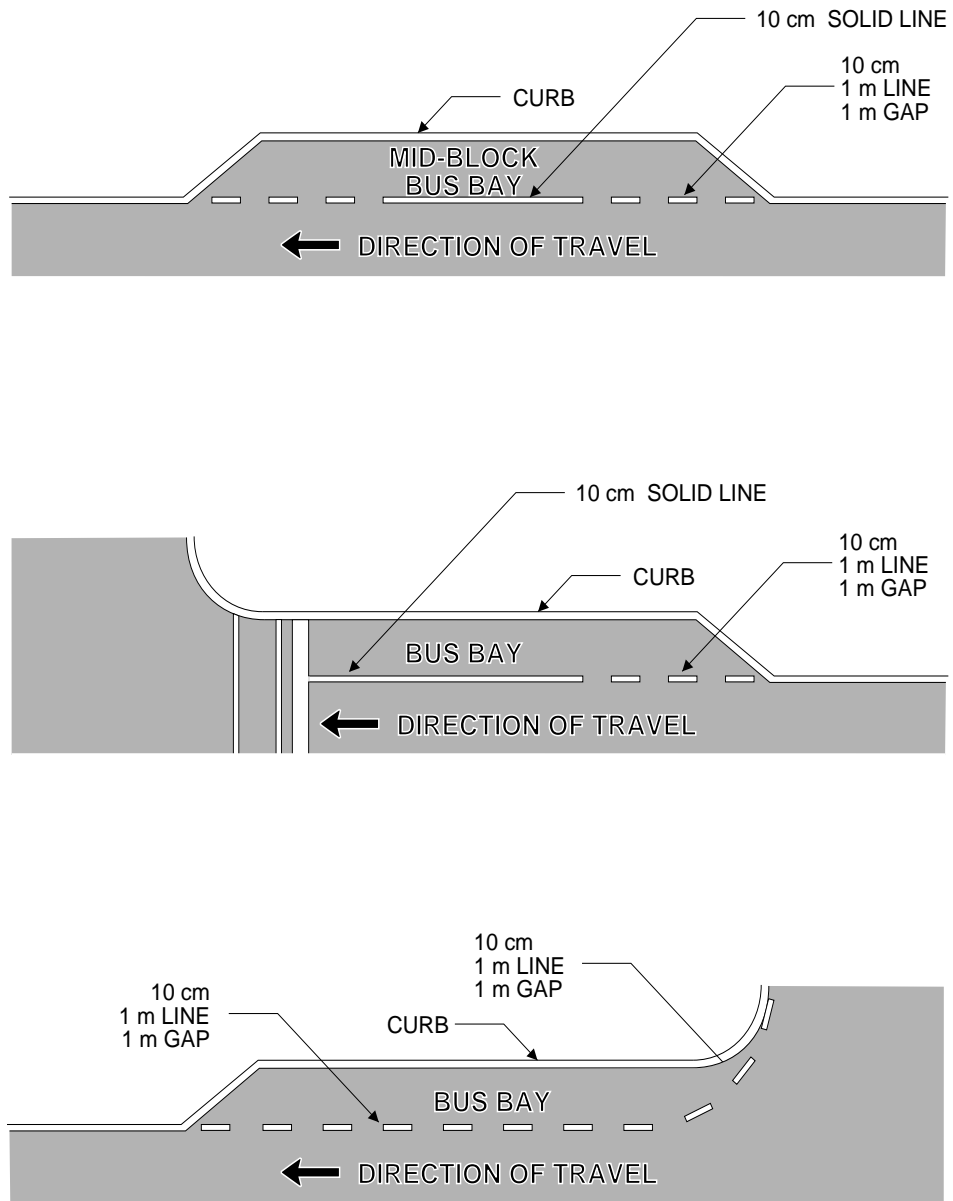
On curves of short radius, short dashes will preserve the appearance of continuity in a broken line.

For additional information on integrating tramway and light rail vehicles with road traffic, refer to Section U.D.18 of the *Urban Supplement to the Geometric Design Guide for Canadian Roads* (Transportation Association of Canada, 1995) and to the *Manual of Geometric Design Standards for Canadian Roads* (Transportation Association of Canada, 1998).

#### *Bus Bays*

Bus bays should be marked to show where there is sufficient space for bus drivers to pull out of the traffic stream easily and park parallel to the curb.

Figure 35 – Typical Markings for Bus Bays



The boundaries of bus bays may be identified by placing a broken white retroreflective line 10 cm wide, with segments and gaps each 1 m long, between the bus bay and the adjacent traffic lane. If the bus bay is located at the approach to an intersection, a solid edge line should be used, as shown in Figure 35, instead of a broken line. A bus bay constructed with a mountable curb separating it from the traveled lanes does not require such markings.

### *Lane Designation*

Reserved lane pavement markings must be used to identify restricted lanes and regulate their operation.

Lanes reserved for the exclusive use of buses and High Occupancy Vehicles (HOV) should be at least 3.6 m wide.

#### • **Full-time Bus/HOV Lane**

A lane reserved full-time for the exclusive use of buses and HOVs should be separated from a normal through lane by a 20 cm wide retroreflective solid lane line, and must be marked with elongated diamond symbol pavement markings. Explanatory pavement marking text may accompany the diamond symbol. Typical pavement markings for full-time with-flow reserved lanes are shown in Figure 36. Markings for full-time contra-flow reserved lanes are shown in Figure 37.

Along approaches to an intersection or interchange where turns are permitted, a wide solid lane line must be dashed to permit lane changes, as shown in Figures 36 and 37.

At the entrance to an at-grade intersection, a normal (10 cm) broken lane line must be used, as shown in Figures 36 and 37, instead of a wide lane line.

A white diamond symbol, shown in Figure 38, must be used to identify a restricted lane. The diamond shape must be 1 m wide and 4 m long, formed of lines 15 or 20 cm wide. Supplementary text may also be used where full-time restrictions apply, and should be elongated to be legible from a distance. Text characters should be no less than 1.2 m long on roads with speeds under 50 km/hr, no less than 1.8 m long on other urban roads, and no less than 2.4 m long on high speed roads. Standard pavement marking letter dimensions are shown in Figures 50 through 52. Text legends consisting of more than one word (such as "HOV ONLY" or "BUS LANE") must be arranged so that the first word is nearest to the road user approaching the restricted lane. Text and elongated diamond markings must be centred laterally in the restricted lane.

The frequency of the restricted lane markings should be based on posted speed, block length, distance from the intersection, and engineering judgement. The following guidance regarding spacing of pavement marking symbols and text is provided:

- On all full-time restricted lanes, the diamond symbol should be placed at least 10 m downstream of the beginning of each block, or 10 m downstream of the downstream transverse line marking a pedestrian crossing.
- For urban applications where intersections are closely spaced, one set of markings should be placed in each block. Additional symbols are appropriate in the following circumstances:
  - On full-time with-flow reserved lanes, additional diamond symbols may be used if right turns are not permitted from the restricted lane.

Figure 36 – Typical Pavement Markings for Full-time With-flow Reserved Lanes

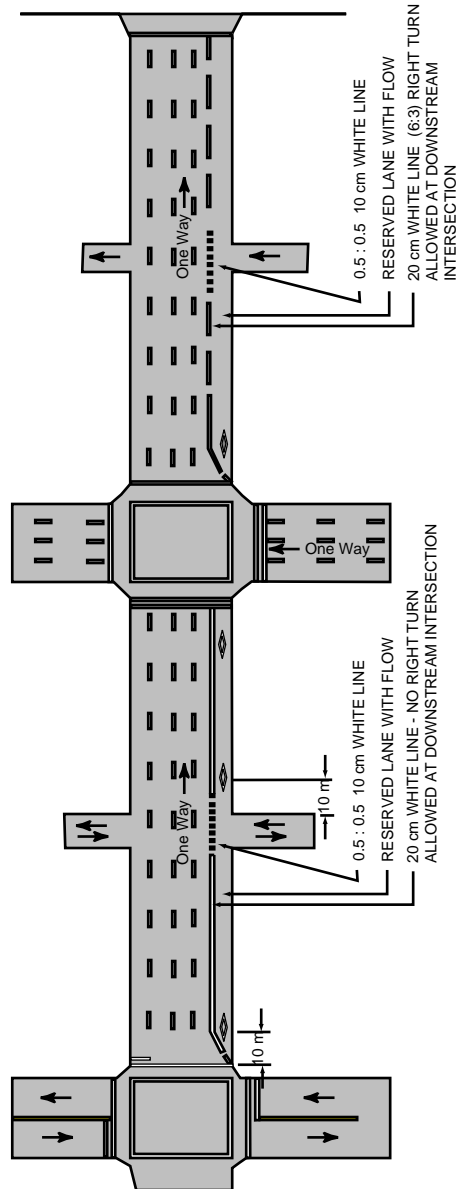


Figure 37 – Typical Pavement Markings for Full-time Contra-flow Reserved Lane

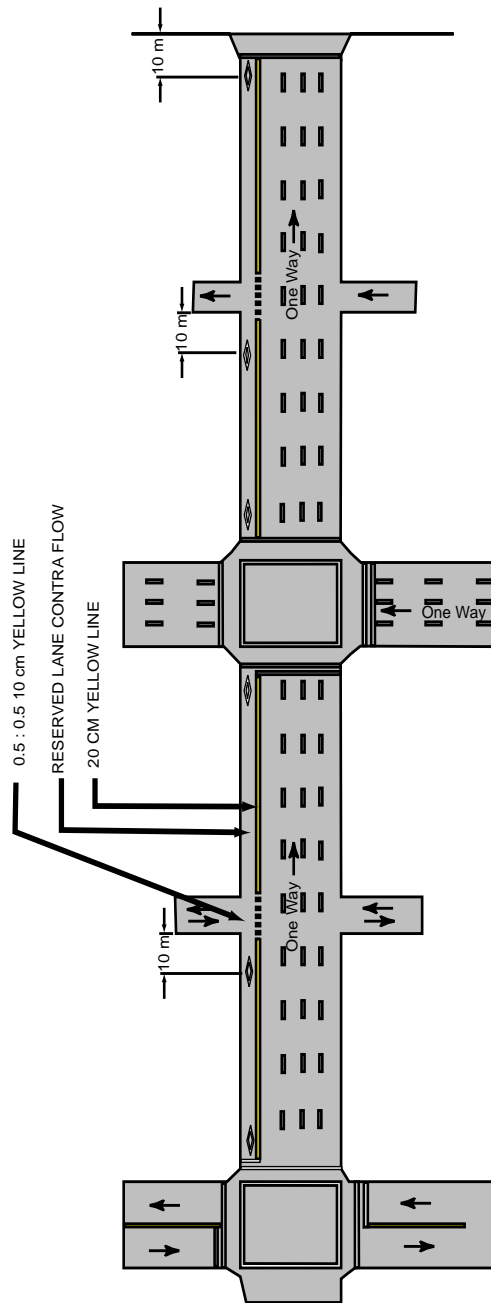
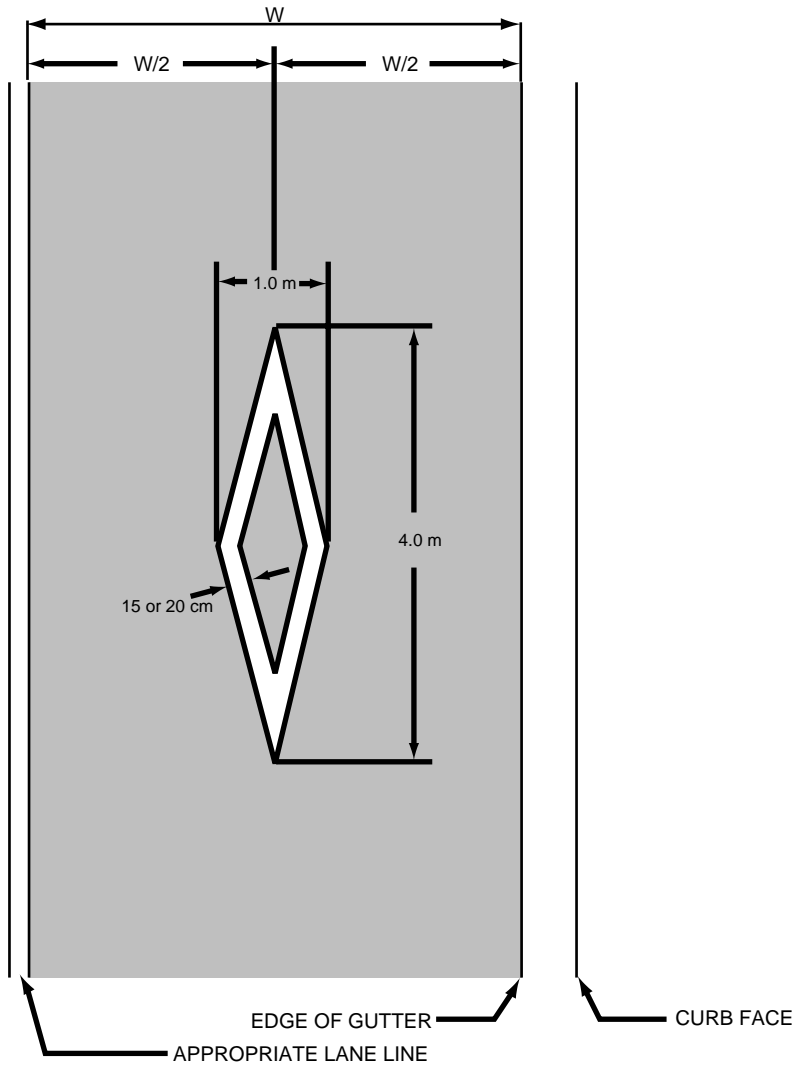




Figure 38 – Diamond Symbol for Reserved Lanes



– On full-time contraflow reserved lanes, additional diamond symbols should be centred 10 m upstream from each intersection or crosswalk.

- Where no other spacing guideline applies, markings may be spaced at a distance (in metres) of four times the posted speed limit value. For example, if the posted speed limit is 50 km/hr, markings may be spaced about  $50 \times 4 = 200$  m apart.

#### • Part-time Bus/HOV Lane

A lane reserved part-time for the exclusive use of buses and HOVs should be distinguished by double white retroreflective broken lane lines, and must be marked with the elongated diamond symbol only. The frequency of the elongated diamond symbol is the same as for full-time bus/HOV lanes.

## Bicycles

Like motor vehicle drivers, bicyclists expect routes that are reasonably free of hazards such as surface irregularities, curb drop-offs, or curbside parking along the bicycle route.

Bicycle lane markings indicate the separation of lanes for motor vehicles and bicycles, and can provide advance information for turning and crossing manoeuvres.

### *Lane Designation*

Bicycle lanes may be marked on the road pavement immediately adjacent to traffic lanes, or physically separated from the roadway on dedicated paved paths.

Bicycle lanes not physically separated from the roadway should be positioned between the paved shoulder and the adjacent traffic lane, and should be at least 1.5 m wide. Where motor vehicle speeds exceed 55 km/hr or heavy commercial vehicles form a significant proportion of the traffic, bicycle lanes should be at least 1.8 m wide.

Bicycle lanes adjacent to roadway travel lanes should be one-way in the same direction as the adjacent traffic. Two-way bicycle lanes should be physically separated from the roadway by a significant terrain feature or a crashworthy barrier.

### *Markings*

If the bicycle lane and traffic lane are contiguous, they should be separated by a 10 cm retroreflective solid white stripe.

Typical pavement markings for bicycle lanes are shown in Figures 39 and 40. The set of markings in Figure 39 indicating "Bicycle Only" should be placed before each major intersection. Either set of markings shown in Figure 39 should be placed at intervals of 100 m to 200 m between intersections. For bicycle lanes that operate only during specified hours, pavement markings showing the hours of operation may be included.

When roadways with bicycle lanes intersect other roads, the solid white line delineating the bicycle lane is normally discontinued some distance before the cross street. If the line continued to the intersection, right-turning motor vehicles would be compelled to remain in their lane right up to the intersection and then turn right across the bicycle lane, cutting off any bicycle through traffic. Discontinuing the bicycle lane line or substituting a broken line for the solid bicycle lane line allows right-turning motor vehicles to merge right into the curb lane before making their turn. Although this is common practice, if substantial conflicts are observed or expected at an intersection between

right-turning vehicles and through bicycles, a through bicycle lane may be marked as shown in Figure 41, 42, or 43. These treatments should be applied with caution, since right-turning drivers may not expect the bicycle through-lane and consequently may fail to yield to through cyclists.

Travel lanes may be marked on two-way bicycle facilities that are wide enough and that are physically separated from the roadway. A broken yellow marking may be used to separate opposing directions of travel. At locations where conditions make it necessary to separate opposing directions of travel (such as where visibility is restricted by structures or shrubbery), a double solid yellow marking should be used to indicate that passing or traveling on the left is not advised.

On facilities that are physically separated from the roadway, bicycles often share the path with pedestrians. If necessary, a white separation line may be used to segregate pedestrians and cyclists, with priority indicated by painted bicycle and pedestrian symbols every 200 m.

## Pedestrians

### *Crossovers*

A pedestrian crossover provides pedestrians with a protected crossing opportunity at an unsignalized location where the crossing volume is insufficient to warrant a pedestrian signal. Within certain volume limits, pedestrian crossovers can be less restrictive to traffic flows than traffic signals. However, crossovers are a lower form of control than traffic signals, and their potential application must be carefully evaluated to ensure effective operation.

Pedestrian crossovers may be applied only by municipalities that have by-laws designating them. For regulatory requirements associated with pedestrian crossovers, refer to *OTM Book 5* and the Highway Traffic Act.

Crossovers should be provided at pedestrian concentration points away from traffic signals or STOP signs, such as at loading islands or midblock pedestrian crossings. Crossovers should also be used to define a safe crossing not otherwise obvious to pedestrians, particularly children. However, crossovers should not be used indiscriminately. An engineering study should be undertaken before they are installed.

Crossovers must be marked as shown in Figure 44 and should be placed where visibility is adequate for both pedestrians and traffic. Because non-intersection pedestrian crossings are generally unexpected by the road user, warning signs should be installed, and adequate visibility provided by parking prohibitions. These measures will help to alert drivers to the approaching crossover.

Figure 39 – Typical Pavement Markings for Bicycle Lanes

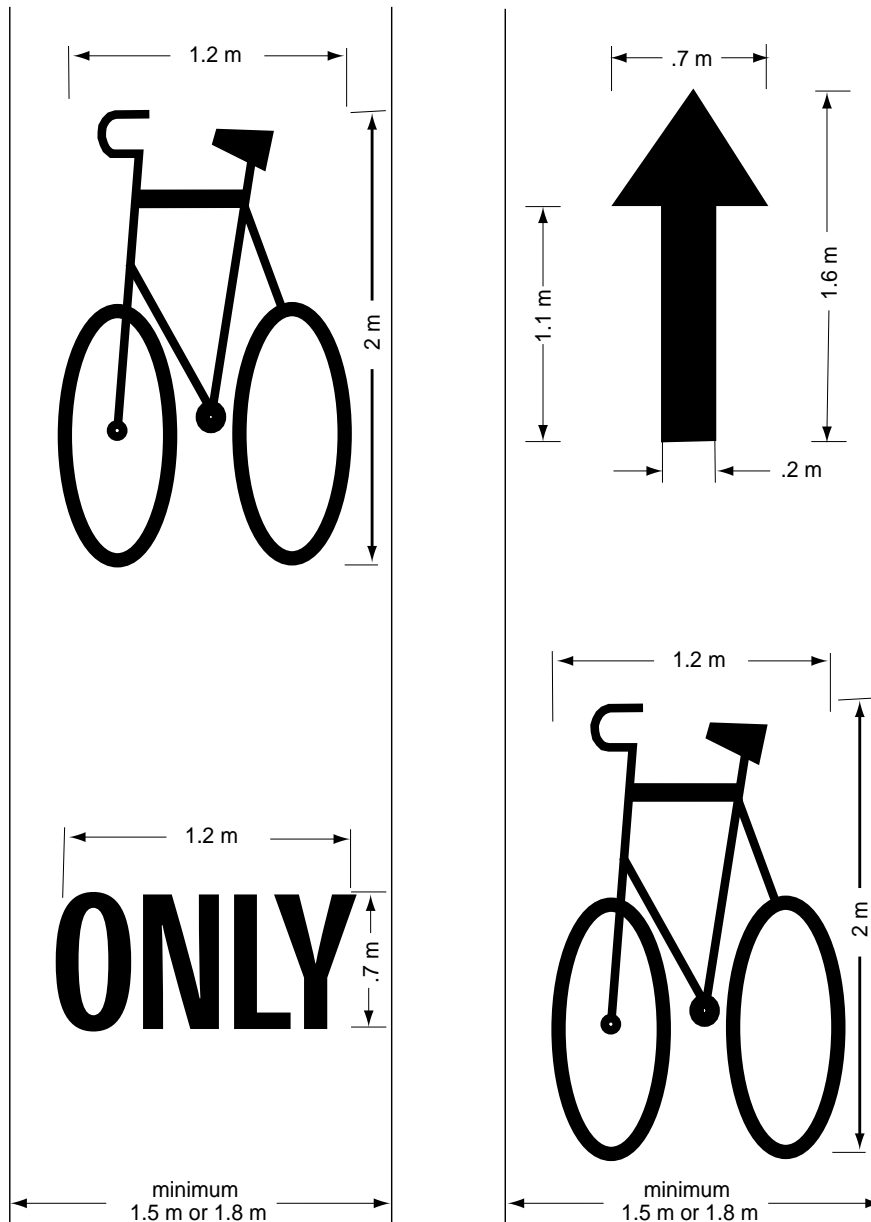


Figure 40 – Typical Pavement Markings for Shared Bicycle and Pedestrian Facilities

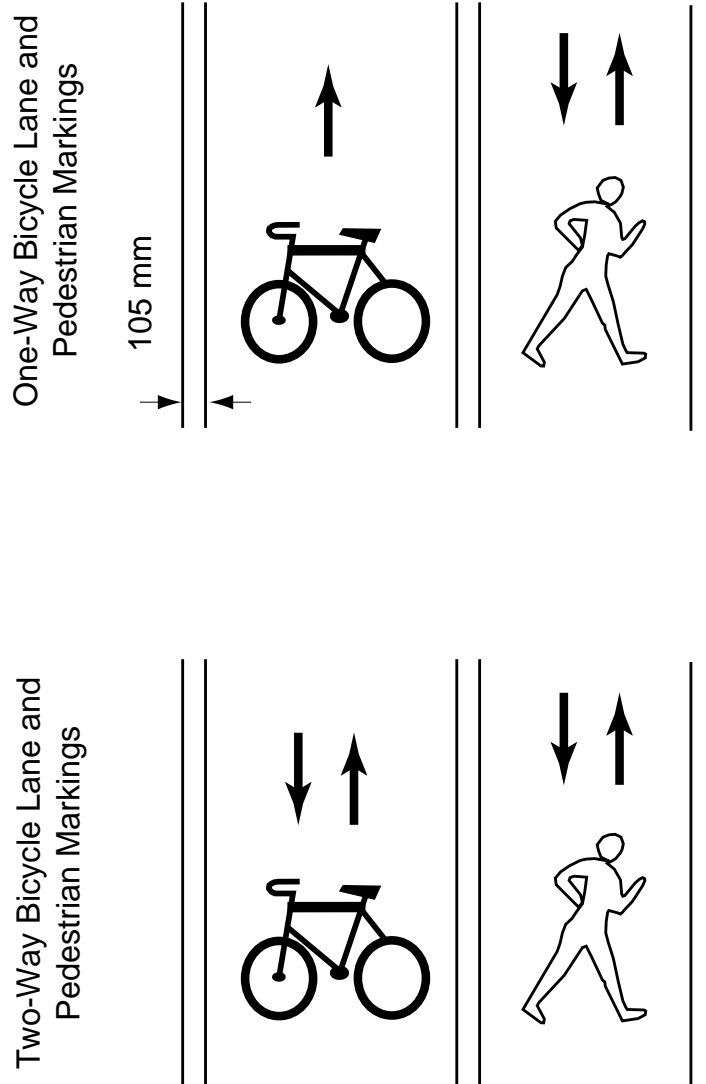


Figure 41 – Typical Pavement Markings for Bicycle Lane at Right-turning Roadway

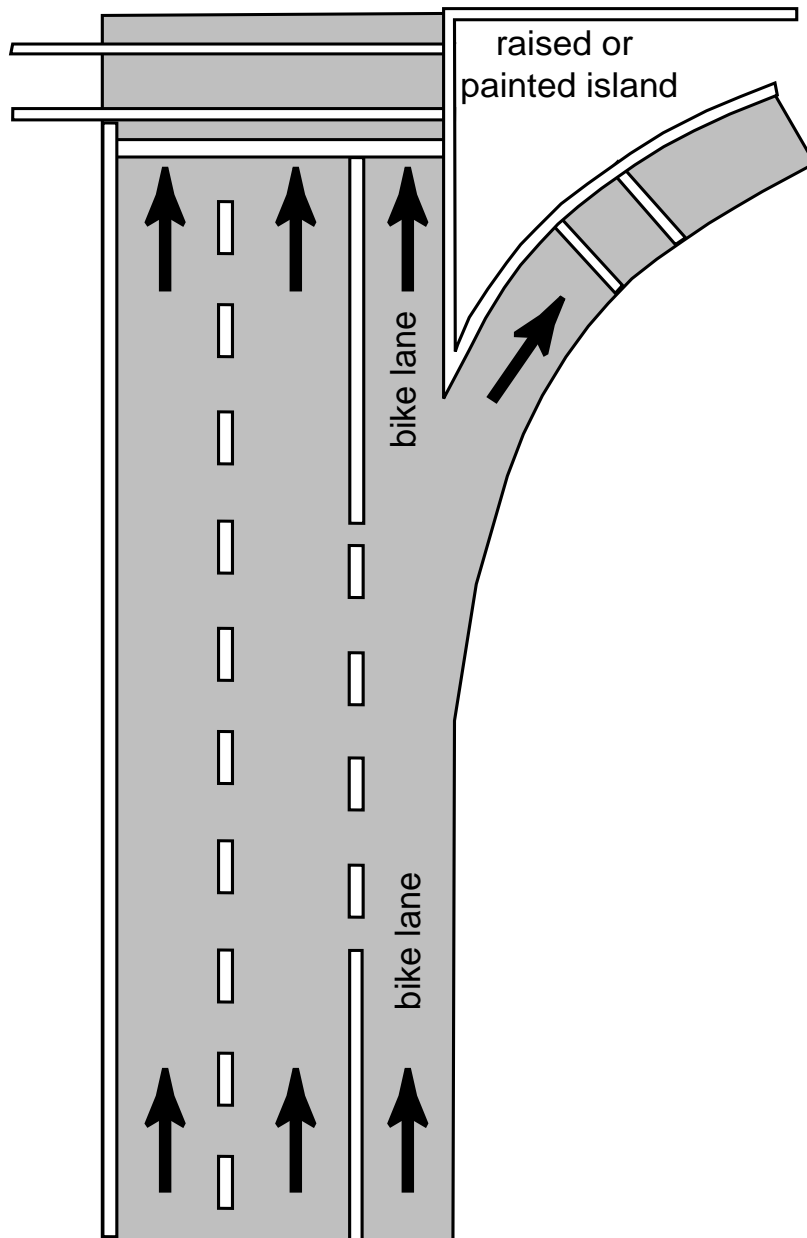


Figure 42 – Typical Pavement Markings for Bicycle Lane at Right-turning Auxiliary Lane

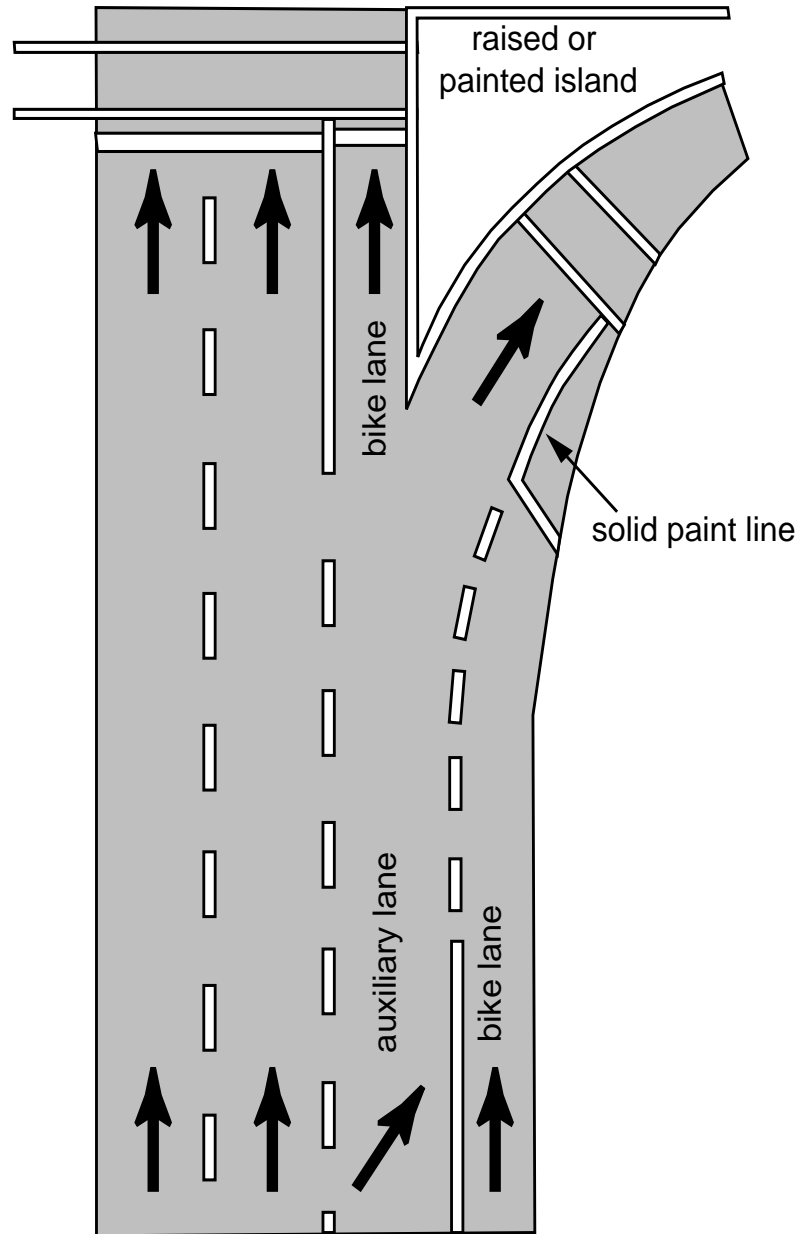
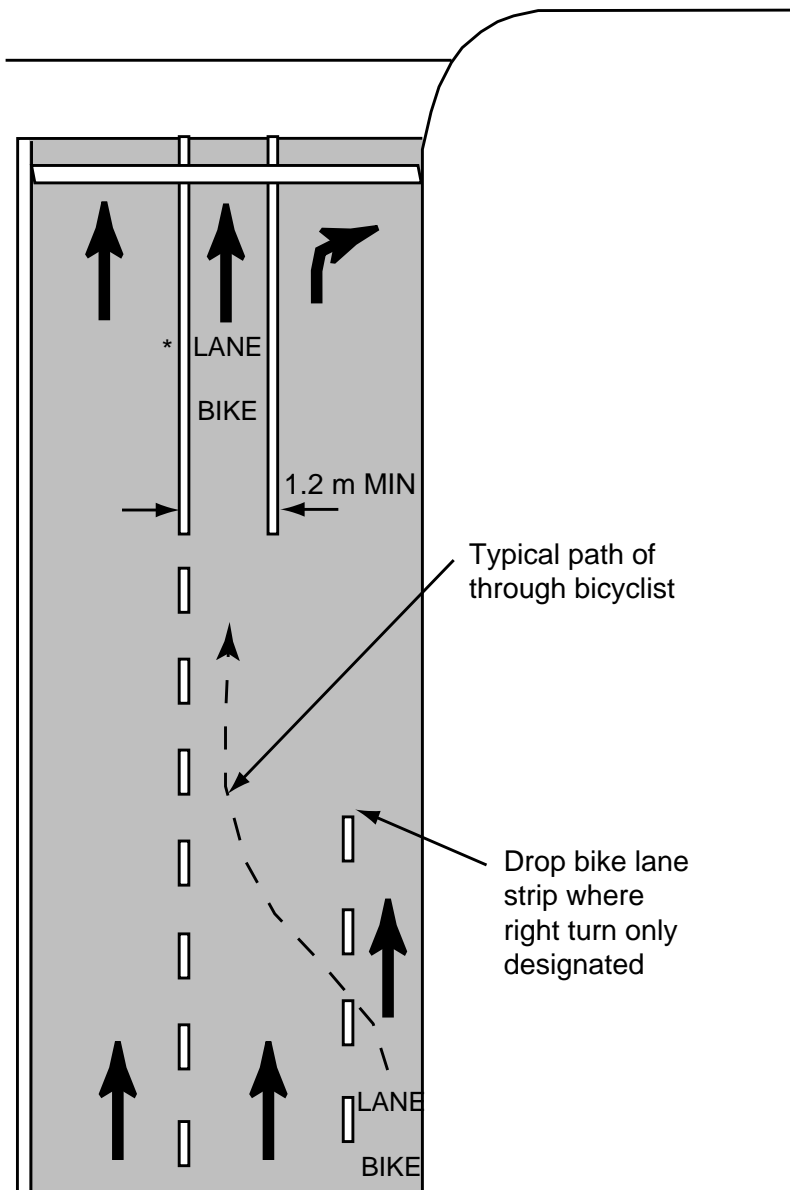


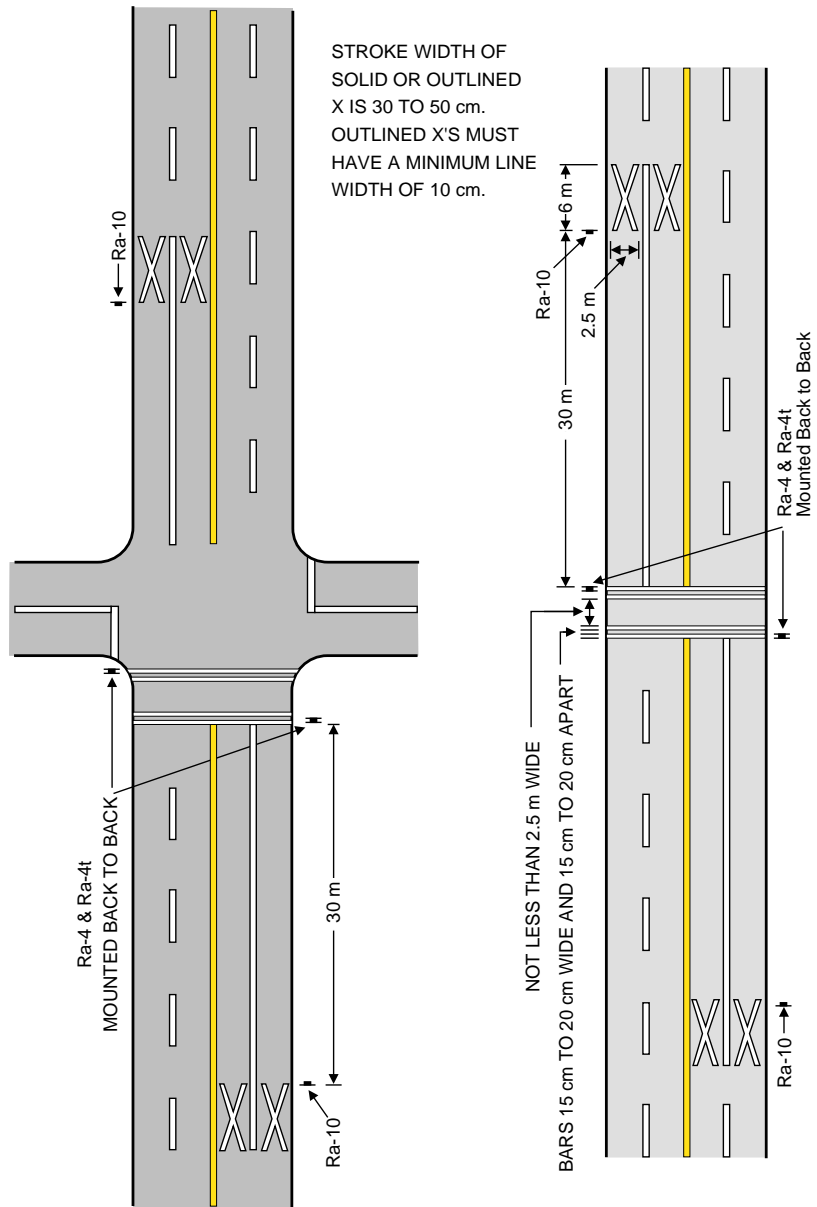
Figure 43 – Typical Pavement Markings for Bicycle Lane at Right-turning Roadway



\* If space is available



Figure 44 – Typical Markings for Pedestrian Crossovers



*Crosswalks*

Crosswalks at intersections are discussed in Section 3.8.

In rural areas, crosswalks should be marked at signalized intersections where pedestrians normally use the signal to cross the roadway, as shown in Figure 32.

In urban areas, crosswalks must be marked at all intersections where there is substantial conflict between vehicular and pedestrian movements. Pedestrian crossings may be marked at non-intersection points where substantial pedestrian movements occur or where a safe crossing point would not otherwise be obvious, particularly to children. Crosswalks must be marked according to the guidelines discussed in Section 3.8 and shown in Figure 33.

Careful consideration should be given to installing crosswalks at uncontrolled locations where vehicles would not otherwise stop. The presence of a marked pedestrian crossing may create a false sense of confidence on the part of pedestrians, particularly children, who may enter the crosswalk expecting that approaching drivers will see them and stop. A discrepancy may exist between pedestrians' expectations and the expectations of approaching drivers who may not expect to find a pedestrian crossing at an uncontrolled location. If a crosswalk at an uncontrolled location is deemed necessary, its safety may be enhanced by the addition of advance markings, warning signs and illumination. Alternatively, a school crossing may be installed if appropriate.

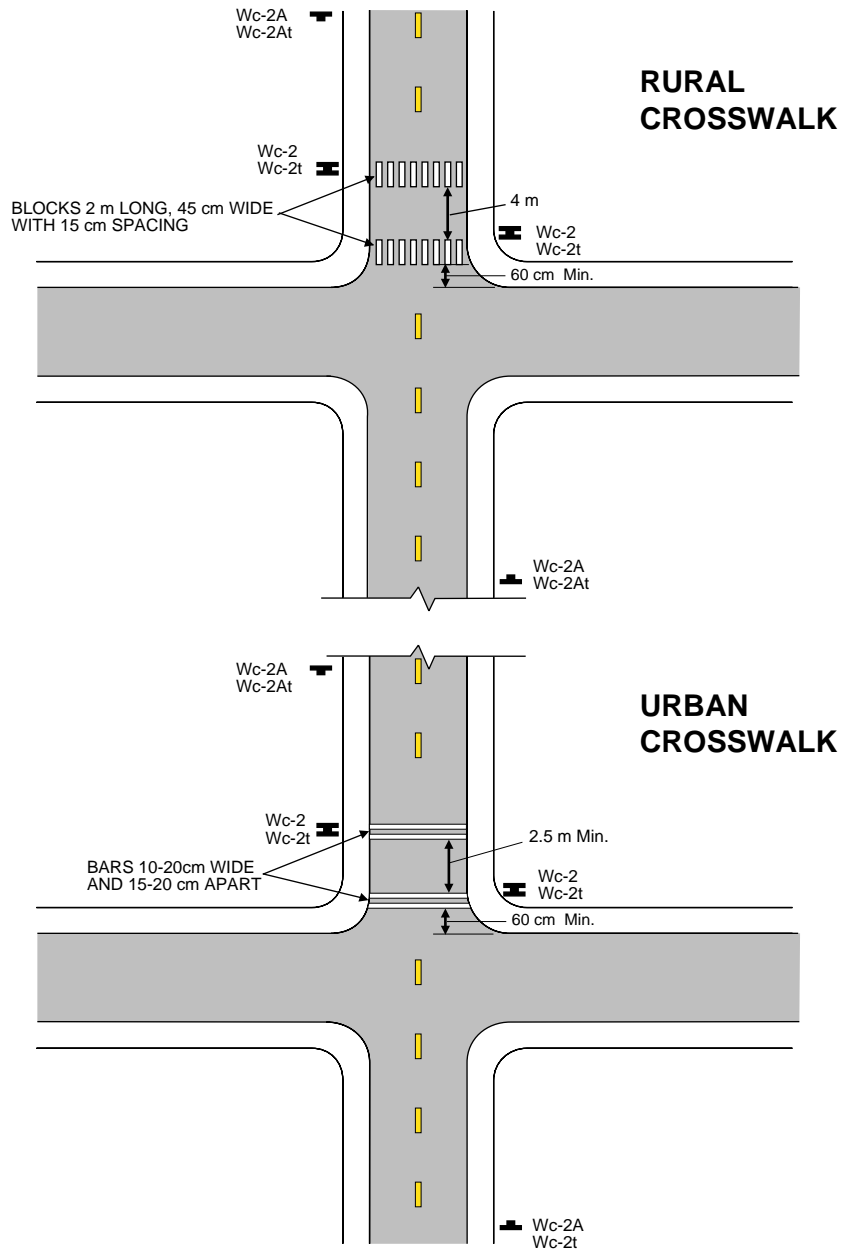
*School Crossings*

Children are normally not as alert as adult pedestrians to the dangers of the roadway. The use of a school crosswalk and appropriate signage help to warn drivers that extra caution is required since children may be present.

Crosswalk markings for supervised school crosswalks, except those at pedestrian crossovers (discussed above) or signalized intersections, must conform to Figure 45. School crosswalks may be supplemented with signs and/or pavement markings warning of a school crossing ahead. Pavement markings stating "SCHOOL" or "SCHOOL XING" may be provided on both approaches to the school crossing.

If used, advance warning text should be elongated to be legible at a distance. Text characters should be no less than 1.2 m long on roads with speeds under 50 km/hr, and no less than 1.8 m long on other urban roads. Standard pavement marking letter dimensions are described in Section 3.12. Text legends consisting of more than one line must be arranged so that the first line is nearest to the road user approaching the crossing. Text markings must be centred laterally in the approach lane(s).

Figure 45 – School Crosswalks for Supervised Crossing



## Railways

### *Crossing Approaches*

Pavement markings are used as one element of an active or passive railway crossing warning system to warn motorists of the presence of a rail right-of-way crossing the road ahead. These markings are vital in alerting drivers to an approaching hazard such as elevated tracks, a change in roadway surface conditions, or a crossing at an angle other than 90 degrees.

Markings must be placed on all paved approaches to grade crossings where grade crossing signals or automatic gates are located, and at all other grade crossings where the prevailing speed of highway traffic is 60 km/hr or greater.

Markings must also be placed at crossings where engineering studies indicate a significant potential conflict between vehicles and trains.

At minor crossings or in urban areas, railway crossing markings may be omitted if an engineering study indicates that other installed devices provide adequate warning and control.

Pavement markings in advance of a grade crossing must consist of the following, as shown in Figure 46:

- A letter "X" 2.5 m wide and 6 m long, with its centre 9 m downstream of the railway crossing sign;
- No-passing markings on two-way roads to prohibit passing by vehicles approaching the railway crossing and, if necessary, by vehicles leaving the railway crossing;
- Two transverse stop lines that are oriented parallel to the nearest railway track. The stop lines must each be 30 cm wide and separated by a 30 cm gap. The stop line nearest the track must be placed outside the crossing gate or 4.5 m from the near rail, whichever distance is greater.

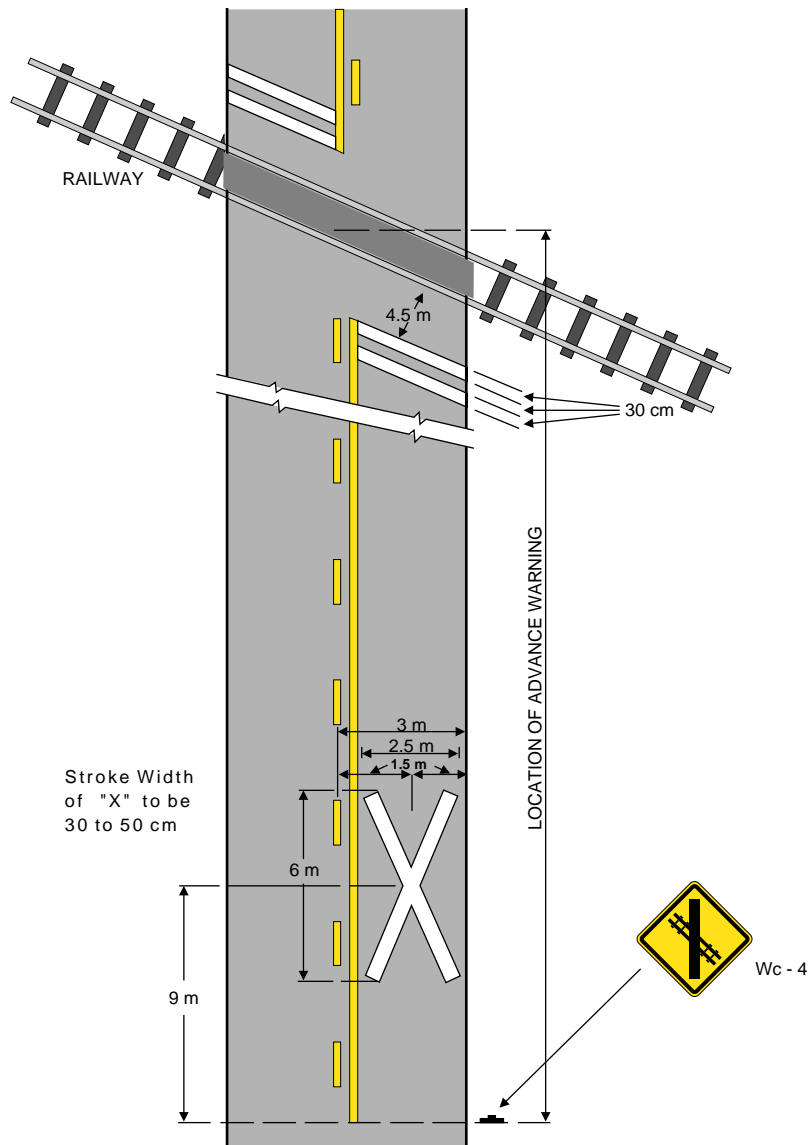
All pavement markings must be of white retroreflective material except for the no-passing markings, which must be of yellow retroreflective material. Pavement markings must be placed on all paved approaches to railway crossings. Where there is more than one lane on an approach, a separate set of markings must be placed in each lane. If needed, supplemental pavement marking symbol(s) may be placed between the advance warning sign and the crossing.

Pavement markings alone are not sufficient warning and must only be used in conjunction with signs and other devices.

Where railroad tracks have been abandoned or their use discontinued, all related signs and markings must be removed. Signs indicating "TRACKS OUT OF SERVICE" may be installed until the tracks are removed or covered.

Figure 46 – Railway Crossing

\* Same Signs in Opposite Direction



### 3.10 Parking

Parking space markings encourage an orderly and efficient use of parking spaces in areas of high turnover. These markings are also useful to identify where parking is prohibited, such as bus stops, loading zones, approaches to a corner, and to help to prevent encroachment on fire hydrant zones.

#### Stalls

##### *Type*

Curbside parking is generally designated as parallel parking. Angle parking should be limited to streets that function primarily as parking areas.

##### *Length*

Parallel parking stalls are 6 m to 6.7 m long to provide manoeuvring space for vehicles. Stalls at either end of a series may be as short as 5.5 m, provided there is no obstruction in front of or behind the stall. Angled parking stalls are generally denoted by lines 5.5 m long.

##### *Width*

Parallel parking stalls are 2.3 m to 3.7 m wide. Stalls should be wider if the parking lane is used as a travel lane during peak periods, or if the parking turnover is high.

##### *Setback*

Parallel parking stalls should have the following minimum setbacks:

- 4.6 m setback on each side from fire hydrants;

- 6.1 m setback on each side of an intersection. Setback should be greater if required for adequate sight distance. Greater setback is especially helpful near uncontrolled intersections, on roads with high operating speeds, or where through vehicles need more room to manoeuvre around left-turning vehicles.

Local statutory prohibitions on parking may supersede these minimums, or may impose additional restrictions. Approaches to pedestrian crossings, traffic signals, bus stops, private driveways, railroad crossings, or fire stations may be subject to such local restrictions. Local parking restrictions must be observed when marking parking stalls.

#### Curb Markings and Restrictions

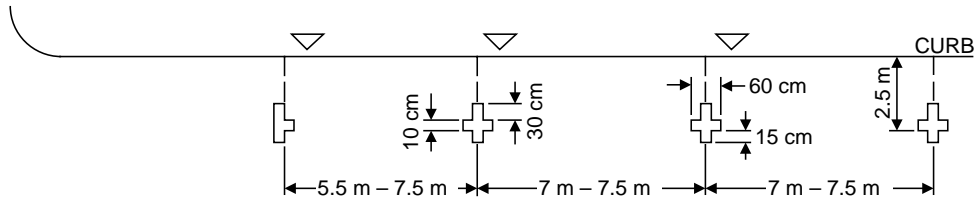
##### *Markings*

Markings used to define parking spaces must be white. The front and rear limits of each parallel parking stall, and the lateral limits of angle parking stalls, should be defined by solid lines approximately 10 cm wide. Examples of acceptable configurations for marking parking stalls are shown in Figure 47.

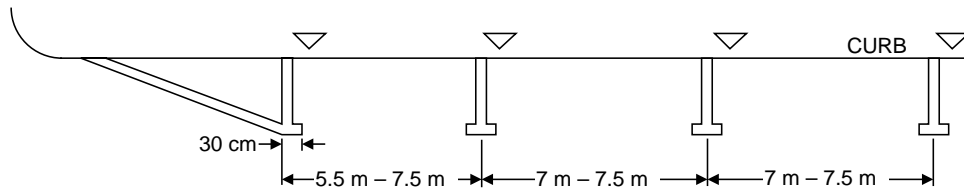
##### *Restrictions*

Signs should be used rather than pavement markings to denote areas where parking is restricted. On narrow roadways, curbside parking is often prohibited on one or both sides. On one-way roads narrower than about 5 m, and two-way roads narrower than about 8 m, parking is generally prohibited on both sides. On one-way roads 5 m to 7.5 m wide, and on two-way roads 8 m to 9.5 m wide, parking is generally prohibited on one side.

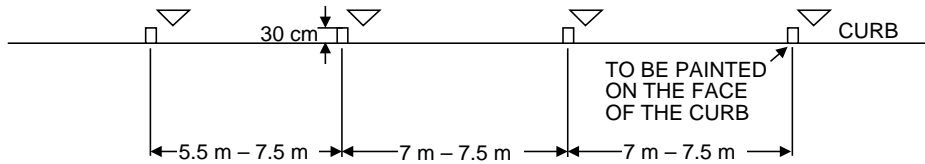
Figure 47 – Typical Markings for Parallel Parking



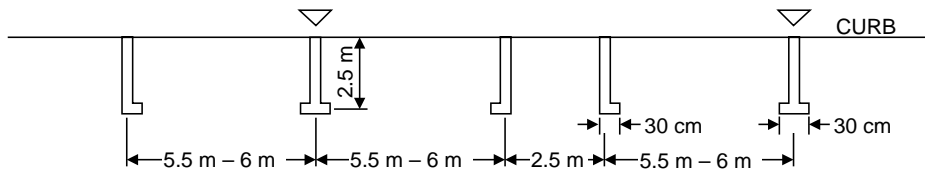
**SINGLE METERS**



**SINGLE METERS**



**SINGLE METERS**



**TWIN METERS**

## Disabled Requirements

### Location

Parking spaces for disabled drivers have specific requirements to accommodate wheelchairs safely and efficiently. Disabled parking spaces should be located in an unobstructed area where the road surface is even and level, with a slope of less than 5% in the longitudinal direction and less than 2% in the cross direction. Disabled parking spaces should have access to a nearby curb cut or ramp for wheelchairs.

### Width

Curbside disabled parking spaces should be restricted to angle parking, unless the space available for parallel parking is sufficiently wide to ensure safe driver-side access for wheelchairs. Disabled angle parking spaces should be at least 3.7 m wide, inclusive of an adjacent unobstructed area 1.0 m wide to allow the driver or passenger to operate a wheelchair between parked vehicles.



### Marking

The disabled access (wheelchair) symbol shown in Figure 48 may be placed in each parking space designated for use by persons with disabilities. A blue background with white border may supplement the symbol, or blue lines may supplement white disabled parking space markings.

## 3.11 Coloured Pavement

### General

Coloured pavements are used to supplement other traffic control devices. Where coloured pavements are used, the traffic control device must be applicable at all times.

Coloured pavement surface should be used only where they contrast significantly with adjoining paved areas.

Care should be taken when considering the use of decorative pavements that use coloured materials (such as brick or coloured aggregate). These materials may convey to the road user a meaning that is not intended.

### Colours

Colours for pavements used to supplement traffic control devices must be limited to the following:

- **Yellow** must only be used for median islands separating traffic flowing in opposite directions.
- **White** must only be used for delineation on shoulders, on channelizing islands where traffic passes on both sides in the same general direction, and for crosswalks.



- **Blue** must only be used for disabled parking spaces.

### 3.12 Words and Symbols

Words and symbols applied to the pavement may be used alone or as a supplement to standard signs for the purposes of guiding or warning traffic. Reference should be made to OTM Book 5 (Regulatory Signs) for information on supporting regulatory signs and by-laws.

The inventory of different word and symbol pavement markings should be minimized to avoid driver confusion and promote effective guidance. Where a symbol is known to be well-understood, it is generally preferable to a word message.

Word and symbol markings must be formed of retroreflective white marking material. Word and symbol markings should be no more than one lane wide, and should be repeated in every lane to which the message applies.

#### Word Messages

Word messages may include regulatory legends (such as STOP markings) or warning legends (such as markings for school zones, pedestrian crossings, or railroad crossings).

A word message should be as brief as possible, consisting of no more than three words. A multi-line message should be placed so that the first word is nearest to the approaching driver.

Due to the low angle at which word and symbol markings are viewed, they must be elongated in the direction of traffic movement to be legible. Dimensions of letters and numerals to be used in word markings are illustrated in Figures 49 to 52

inclusive. The longitudinal space between lines in multi-line word messages should be at least three times the height of the letters on low speed roads, and may increase with increased speed to a maximum of ten times the height of the letters.

#### Symbols

Lane-use arrow pavement markings, as shown in Figure 53, may be used in two-way left-turn lanes, as shown in Figure 34, and in right-turn and left-turn bays.

Where a through lane becomes a mandatory turn lane, lane-use arrow pavement markings must be placed to warn vehicles that a mandatory turn is approaching. Where symbol arrows are used to warn of a mandatory movement, they must be accompanied by standard signs and may be accompanied by the word marking ONLY.

In situations where a lane reduction transition occurs, the lane reduction arrow markings may be used.

The longitudinal space between repeated symbols such as arrows should be at least three times the height of the symbols on low speed roads, and may increase with increased speed to a maximum of ten times the height of the symbols.

Where wrong-way movement is possible, directional arrow markings may be placed near the downstream terminus of a ramp or channelization. The arrow indicates the correct direction of travel for all drivers, including those attempting to travel the wrong way on a one-way roadway.

The disabled access (wheelchair) symbol may be placed in parking spaces designated for use by persons with disabilities. A blue background and white border may supplement the wheelchair symbol shown in Figure 48.

Figure 49 – Standard Pavement Markings (Numerals for Rural Highways)

ALL MEASUREMENTS IN cm

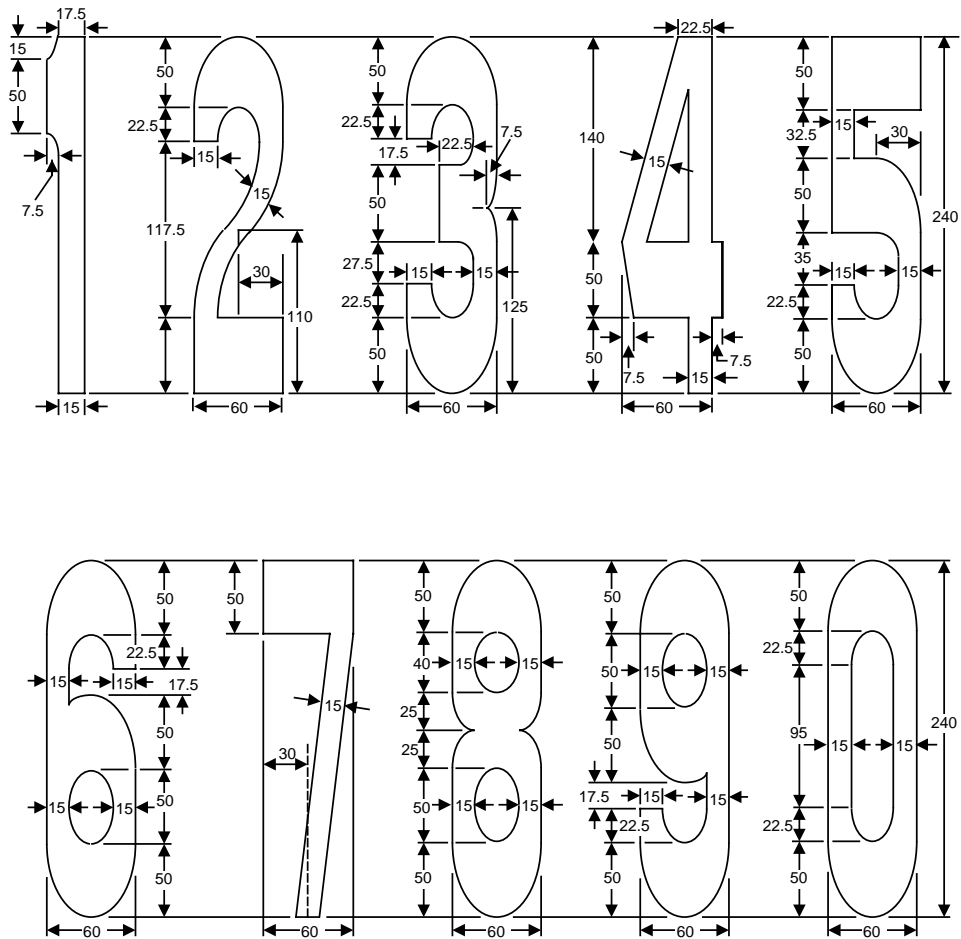


Figure 50 – Standard Pavement Markings (Letters for Rural Highways)

ALL MEASUREMENTS IN cm

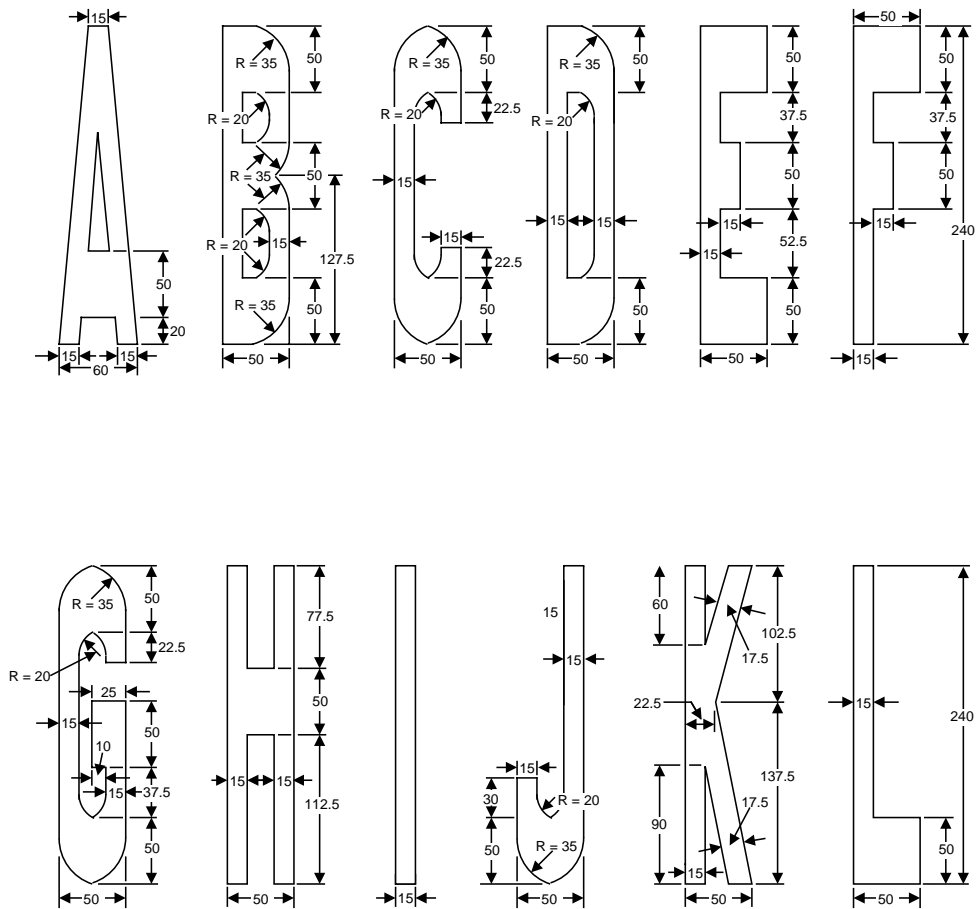


Figure 50 – Standard Pavement Markings (Letters for Rural Highways) (cont'd)

ALL MEASUREMENTS IN cm

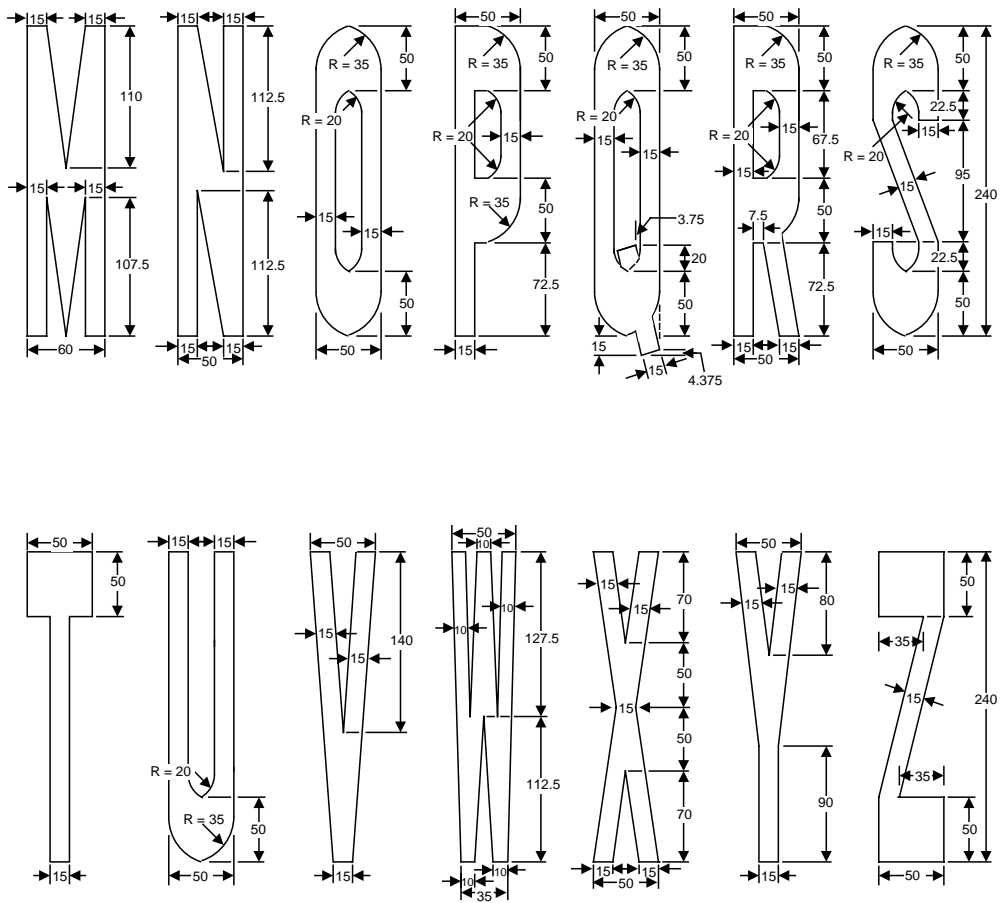


Figure 51 – Standard Pavement Markings  
(Numerals and Letters for City Streets – Minimum Size)

ALL MEASUREMENTS IN cm

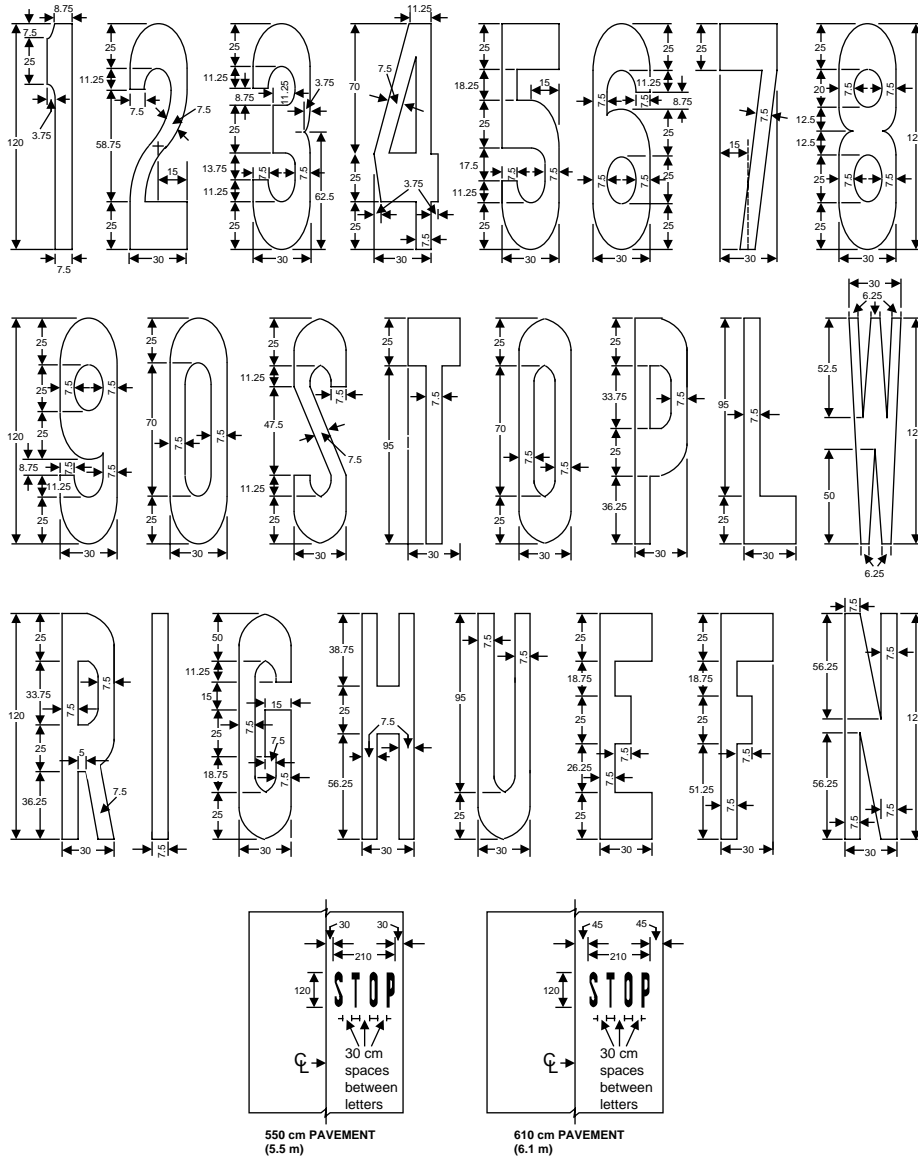


Figure 52 – Standard Pavement Markings  
(Numerals and Letters for City Streets – Recommended Size)

ALL MEASUREMENTS IN cm

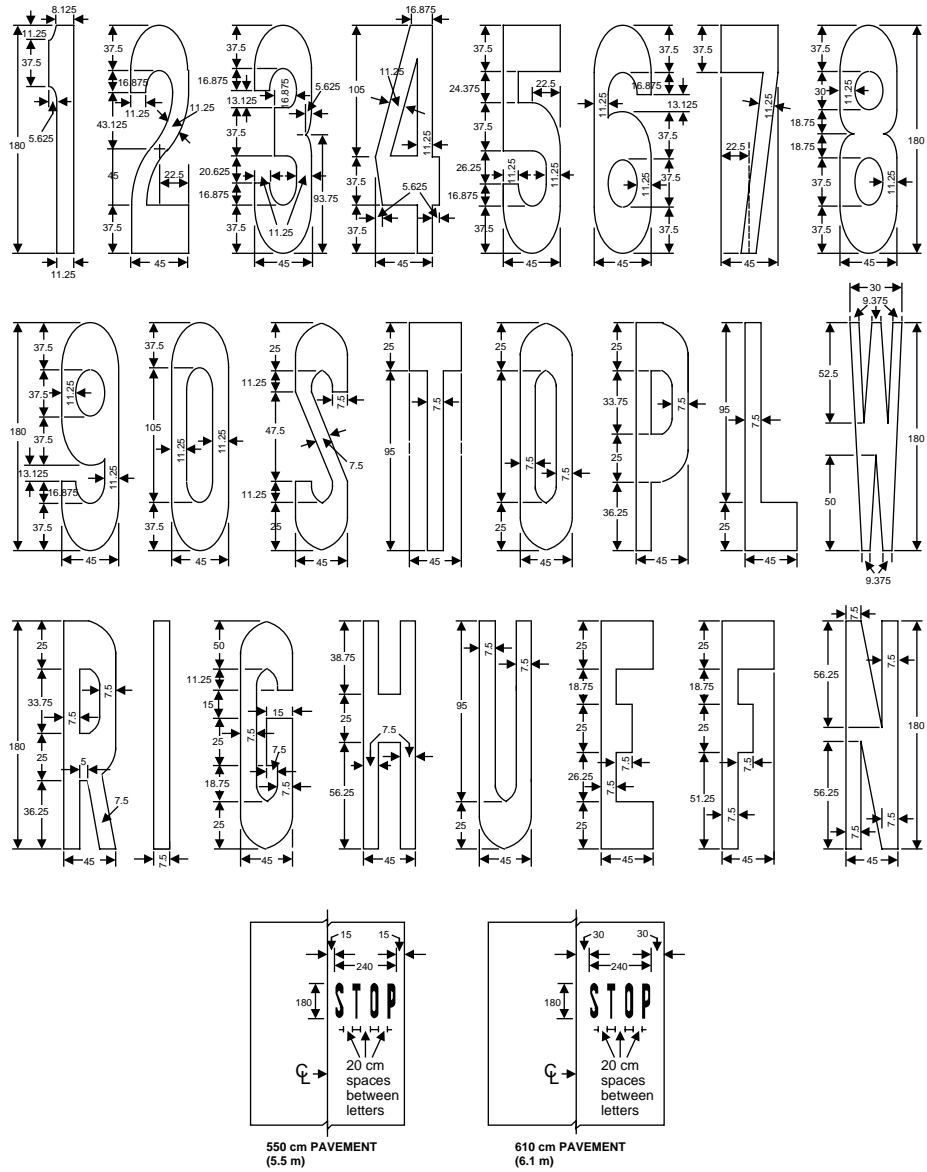
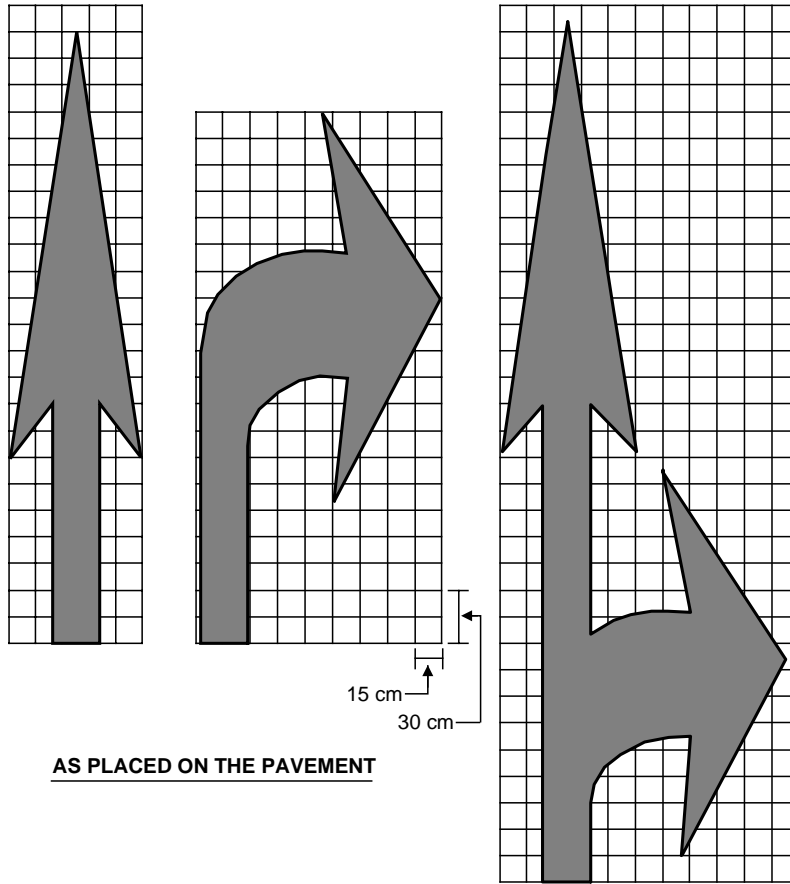
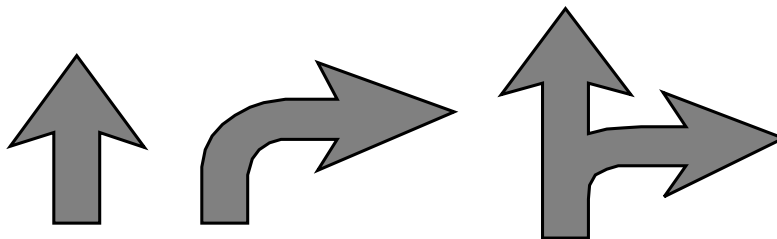


Figure 53 – Standard Pavement Markings (Arrows)



AS PLACED ON THE PAVEMENT



AS SEEN BY THE MOTORIST

---

## 4. Delineation

### 4.1 General

Delineation of the roadside during the daytime can be accomplished effectively with pavement markings. However, nighttime visibility often requires the use of delineators to provide long-range delineation of the roadway alignment. An important advantage of delineators is that they remain visible when the roadway is wet or covered with snow. This advantage allows roadside delineators to continue to guide drivers, even in adverse weather conditions.

The operators of winter maintenance vehicles are often called upon to perform winter maintenance operations in conditions of reduced visibility. Like other drivers, they too receive beneficial guidance from roadside delineation.

Various forms of post-mounted delineators (PMDs) have gained widespread acceptance as a roadway delineation method to provide sufficient visibility during periods of rain or snow when pavement markings can be obscured.

#### Purpose

Delineators are small retroreflective devices that are erected in series to guide drivers. They are placed adjacent to the shoulder (in rural areas) or on the edge of the traveled portion of the roadway (in urban areas). Delineators describe the horizontal alignment of the roadway and help the driver to identify its limits. Delineators are guidance devices and are not intended as warning devices.

Most studies of the effectiveness of PMDs have shown a safety benefit. However, in some studies, an increase in operating speeds and a tendency to drive closer to the edge line followed the introduction of PMDs. Road authorities should be aware that the presence of delineators may have adverse effects on nighttime driving behaviour on roads with low geometric standards. For this reason, it may be desirable to monitor the night-time behaviour of drivers after the introduction of new delineation on roads with low geometric standards.

#### Colours

Colour specifications have been established by the American Society for Testing and Materials (ASTM) and the Canadian General Standards Board (CGSB). All colours used on delineators must conform to ASTM specification D4956-90 or its subsequent revisions, or to CGSB specification 62-GP-11M or its subsequent revisions.

Fluorescence can be used to achieve the required colour specifications. Fluorescence has enhanced visibility at dawn and dusk, but limited durability in most current non-prismatic sheeting products.

Under both daytime and nighttime illumination PMDs must be either yellow or white. Red reflectors may be used on truck escape ramps and on the reverse side of a delineator on a one-way ramp or roadway, where they would be visible to a road user traveling in the wrong direction.

#### Design

Delineators must be capable of clearly retroreflecting light under normal atmospheric conditions. Delineators should show the same shape and colour by night as by day.



Effective January 1, 2002, all in-service delineators must, as a minimum, employ materials conforming to the requirements of the American Society for Testing and Materials (ASTM) Specification D4956-90 or its subsequent revisions for Type III (high intensity) and Type IV (prismatic) materials.

### Retroreflectivity

Most common retroreflective devices use either a glass bead impregnated sheeting or cube corner prismatic unit to provide retroreflectivity. In both types of devices, the optical elements are sealed in a plastic medium to retain their retroreflective properties when exposed to rain. Cube corner prismatic units are brighter than those with glass bead impregnated sheeting. White retroreflectors of either type are brighter than yellow retroreflectors.

It is important to note that a measurable increase in retroreflectivity will not necessarily result in a proportional increase in visibility. Visibility is also dependent on environmental factors (fog, rain, and available light), human factors (driver age and attention), vehicle factors (headlight aim and windshield condition), and road curvature.

### Installation and Removal

Devices should be installed so that they are within the cone of vision of the driver, in order to command attention and allow adequate time for the proper response. Delineators must be positioned at 1.25 m to 4 m from the edge of pavement. They should usually be placed 0.6 m to 2.4 m beyond the outside edge of the shoulder, or, if appropriate, in line with the roadside barrier that is 2.4 m or less beyond the outer edge of the shoulder.

Delineators should be placed a constant distance from the edge of the roadway. If there is an obstruction between the pavement edge and the extension of the line of delineators, the delineators should be adjusted to present a smooth line passing between the obstruction and the road edge.

If a delineator is required near a guide rail, or is obstructed by a guide rail (as on a horizontal curve), the delineators should continue uninterrupted through the guide rail section. PMDs should be placed as close as possible behind the guide rail, or on the guide rail. Where guide rail PMDs are provided, other retroreflective bands or strips normally attached to the guide rail to delineate its presence may be eliminated.

When uniform spacing is interrupted by a feature such as a driveway or crossroad, the delineator may be relocated by a distance up to one-quarter of the uniform spacing. If the delineator cannot be placed within this range, it should be eliminated.

Removal of PMDs is usually not necessary. Normally, the retroreflective units are replaced and the posts left in place. Removal occurs only if the post is struck by a vehicle or if a construction project or other program makes PMD removal necessary. Removal of standard steel-post PMDs requires specialized equipment and can be costly. Removal of flexible-post PMDs can usually be accomplished by hand.

### Maintenance

PMDs are vulnerable to damage by heavy snowdrifts, snowplows, or other roadside maintenance vehicles. In high snowfall areas, the condition of PMDs should be observed at the end of the snow season. PMD longevity can also be

reduced by high truck traffic, vandalism, vehicle collisions, and changeable traffic conditions. Maintenance or replacement of damaged PMDs should be periodically scheduled.

## 4.2 Curb Markings for Delineation

Reflectorized solid yellow markings may be placed at the tips of islands located in the line of traffic flow where the curb channels traffic to the right of the obstruction. Reflectorized solid white markings may be used when traffic is permitted to pass on either side of the island.

Where island curbs become parallel to the direction of traffic flow, it is not necessary to mark the curbs unless a study indicates the need for this type of delineation. If these curbs are marked, the colours must conform to the general principles of marking described in Section 3.1 of this Book.

Curbs at openings in a continuous median island do not need to be marked unless the need has been demonstrated.

## 4.3 Delineators

### Colours

Delineators used on the through portion of a roadway must be either yellow or white, and conform to the colour of the edge line as described in Section 3.1 of this Book. An exception is interchange ramps, where yellow delineators must be used, whether on the left or right side of the ramp roadway.

### Applications

Delineators assist motorists in correctly interpreting changes in roadway alignment, lane reductions and transitions at preview distances greater than those provided by pavement markings. They may also be beneficial in reducing run-off-the-road type collisions on long tangent highway sections. Delineators visually reinforce the proper path for the driver to follow, reducing the probability of confusion and error resulting from unexpected changes in the roadway. Specific areas in which delineators are required or should be considered are described below.

#### *Roads, Ramps and Curves*

Delineators are appropriate where there are changes in the horizontal alignment, particularly where the nighttime collision frequency is high or the roadway alignment at night is not otherwise apparent.

Delineators must be provided on medians and on the outside of interchange ramps. They must also be provided on the right side of freeways, but may be omitted, through tangent sections only, provided any one of the following conditions is met:

- the route is substantially straight, with long sections of tangent alignment, and road side delineators are used in advance of, and through, all curves;
- roadway pavement markers are used continuously on lane lines throughout all curves and tangent sections to supplement pavement markings; or
- the roadway is fully illuminated, at and between all interchanges.

Before omitting delineators on tangent sections of freeways, it should be confirmed that they are not required for the guidance of winter maintenance vehicles.

Delineators should be used on the approaches to, and around, all horizontal curves where the safe speed (as measured by ball bank indicator) is less than the speed limit. When used on sections of undivided roadway, bidirectional white delineators (delineators visible from both approach directions) or back-to-back unidirectional white delineators must be installed on the outside of curves.

#### *Acceleration and Deceleration Lanes*

Double or vertically elongated delineators may be installed at 30 m intervals along acceleration and deceleration lanes.

#### *Lane Width Transitions*

Delineators of the appropriate colour may be used to indicate the narrowing of the pavement where either an outside or inside lane merges into an adjacent lane. The delineators should be used adjacent to the reduced lane or lanes for the full length of the transition, and should be spaced to indicate the reduction, as shown in Figures 54, 55, and 56.

Delineators are not necessary for traffic flow moving in the direction of a wider pavement or on the side of the roadway where the alignment is not affected by the lane reduction.

Delineators should be provided on the approaches to and over narrow bridges and culverts.

On a highway with continuous delineation on either or both sides, delineation should be carried through transitions, where delineator spacing may be reduced.

#### *Median Emergency Crossovers*

Where median crossovers are provided for official or emergency use on divided highways, these crossovers should be marked by a double yellow delineator. These delineators are to be placed on the left side of the through roadway on the far side of the crossover for each roadway.

#### *Truck Escape Ramps*

Red delineators should be placed on both sides of truck escape ramps. The delineators should be spaced at 15 m intervals for a distance sufficient to identify the ramp entrance. Delineator spacing beyond the ramp entrance should be adequate for guidance according to the length and design of the escape ramp.

#### *Median Barrier Delineation*

Delineators may be placed on the top or side of a median barrier to indicate its alignment. The choice of top- or side-mounted delineators should be made with reference to expected positioning and exposure:

- If mounted on a centre barrier, the visibility of top-mounted delineators can be reduced by the glare from opposing headlights.
- Top-mounted barrier delineators, or side-mounted delineators placed close to the top of the barrier, can be covered by an accumulation of snow during the winter.
- Side-mounted barrier delineators can be exposed to splashing from passing traffic. The resulting layer of salt dust or road film can reduce their visibility.

Figure 54 – Ends of Divided Highways  
(Two Lane to Four Lane Divided – Offset Centre Lines)

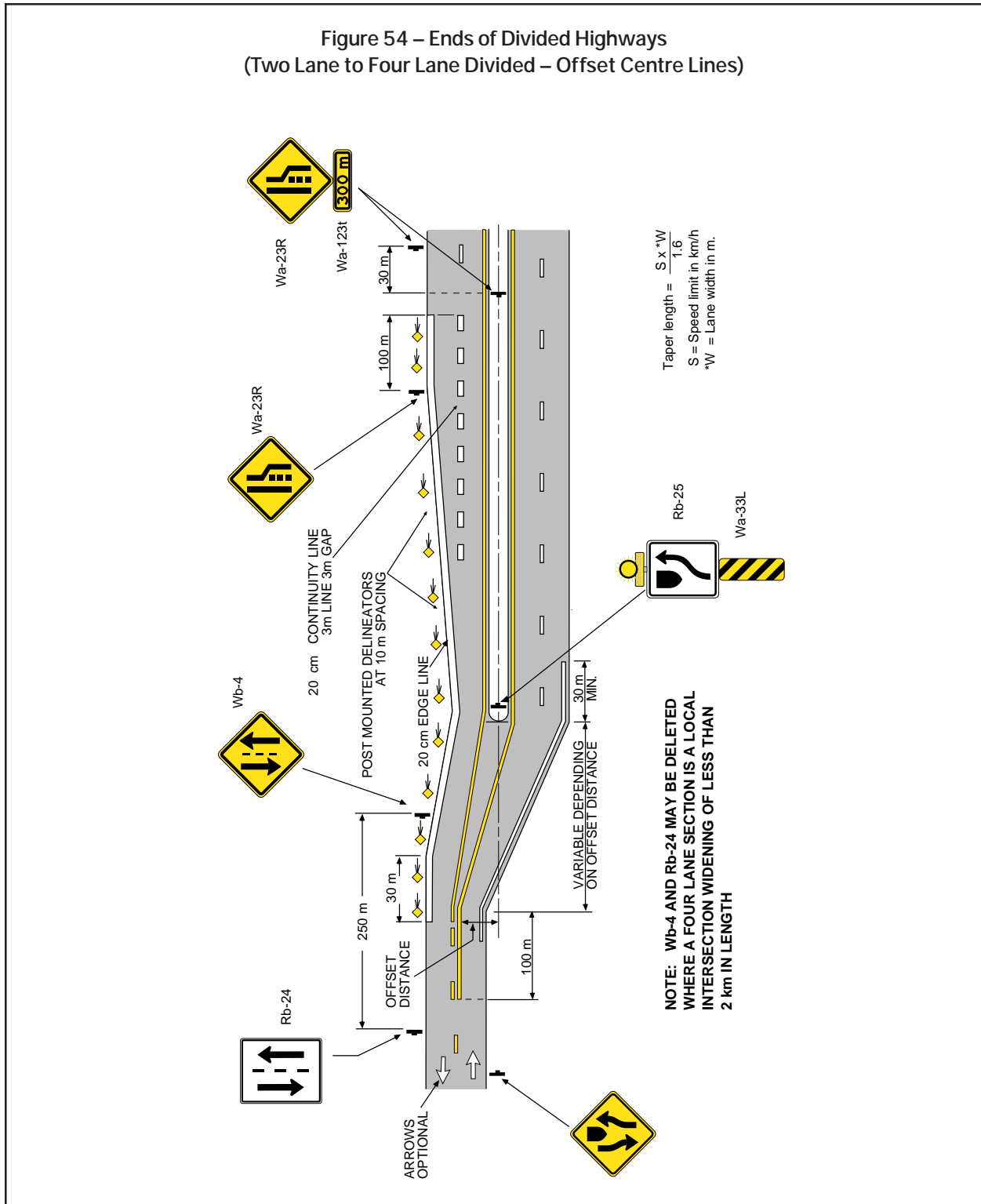


Figure 55 – Ends of Divided Highways  
(Four Lane to Four Lane Divided)

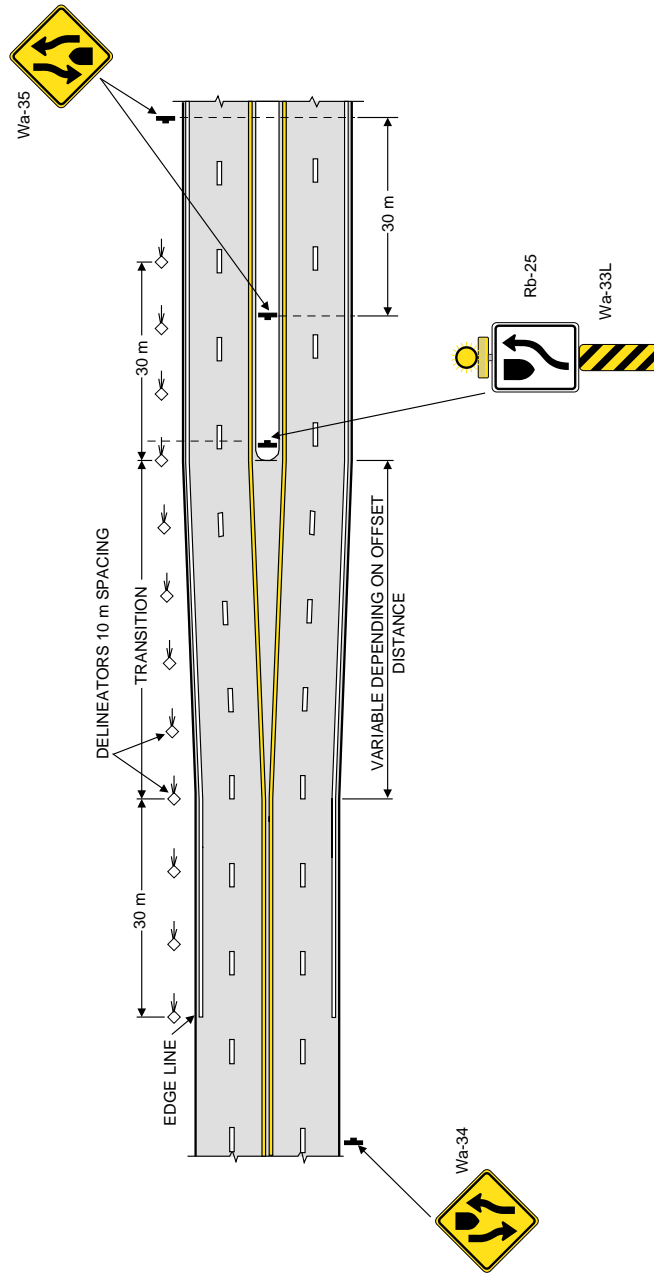
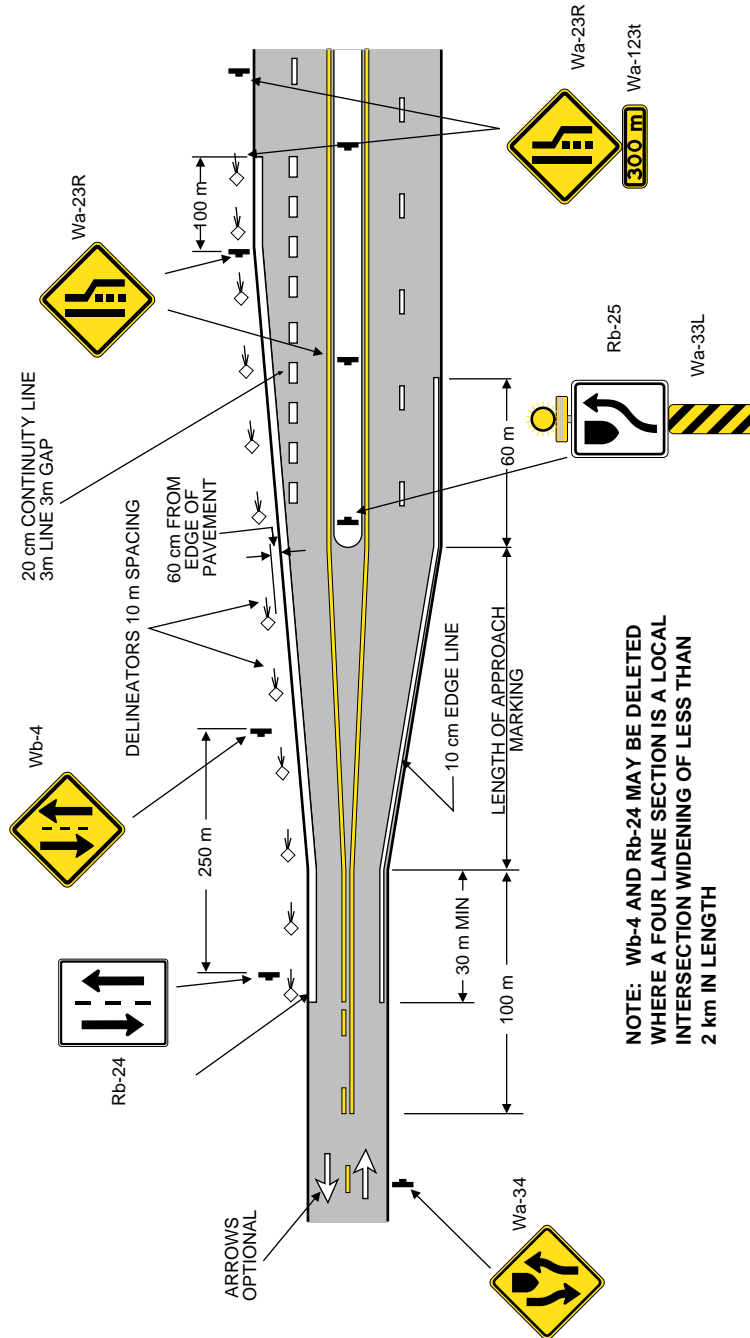


Figure 56 – Ends of Divided Highways  
(Two Lane to Four Lane Divided)



**NOTE: Wb-4 AND Rb-24 MAY BE DELETED WHERE A FOUR LANE SECTION IS A LOCAL INTERSECTION WIDENING OF LESS THAN 2 km IN LENGTH**

*Delineation for Winter Maintenance Operations:*

In circumstances where delineators might not otherwise be considered necessary to guide road users, they may be required to guide the operators of winter maintenance vehicles engaged in winter maintenance operations. This type of delineation is commonly referred to as "snowplow delineation".

While it is specifically intended to assist winter maintenance vehicle operators, snowplow delineation provides added guidance for all road users.

When used, snowplow delineation should be installed in the following circumstances:

- in the median of a divided roadway, where the median is either raised or depressed;
- on the median barrier of a divided roadway, where one is present;

**Table 4 – Spacing of Highway Delineators on Horizontal Curves**

Curve Radius (m)	Degree of Curvature (°)	Spacing on Curve (m)	Spacing in Advance of Curve (m)		
			1st Space	2nd Space	3rd Space
1750	1	27	48	60	60
580	3	15	28	48	60
350	5	12	22	36	60
250	7	10	18	32	60
195	9	9	16	29	56
145	12	7	15	24	48
115	15	7	13	21	44
95	18	6	12	20	39
85	21	6	10	18	36
70	25	6	10	16	35
60	30	5	9	15	30
			3rd Last Space	2nd Last Space	Last Space
			Spacing Beyond Curve (m)		

- the right side of divided and undivided roadways, through horizontal and vertical curves; and
- the right side of divided and undivided roadways, on tangent sections where the roadway is not illuminated.

The design, location and spacing of snowplow delineators should comply in all respects with the guidelines for delineators contained within this Manual.

### Placement and Spacing

#### *Post-mounted Delineators*

PMDs should be mounted on suitable supports so that the top of the highest retroreflector is 1.2 m above the near roadway edge.

On straight sections of roadway, PMDs should be spaced no more than 60 m apart.

**Table 5 – Spacing of Chevron Alignment Signs on Horizontal Curves**

Radius (m)	Degree of Curvature (°)	Spacing on Curve (m)	Spacing in Advance of Curve	
			1st Space (m)	2nd Space (m)
1750	1°	80	145	150
580	3°	45	85	145
350	5°	35	65	110
250	7°	30	55	95
195	9°	30	50	90
145	12°	20	45	70
115	15°	20	40	65
95	18°	20	35	60
85	21°	20	30	55
70	25°	20	30	50
60	30°	15	30	45

Note: On freeway exit ramps and free flow channelizations, the Chevron Alignment signs shall only be erected on the curves, and not in advance of the curves.



PMD spacing should be adjusted on the approaches to and along horizontal curves so that five PMDs are always visible to the right of the directional dividing line on a two-lane roadway, or to the right of the right-hand lane of a multi-lane roadway.

Table 4 shows the recommended spacing for PMDs on horizontal curves. Spacing for specific radii not shown may be interpolated from the Table. Three PMDs should be placed in advance of the curve and three beyond the curve at intervals shown in Table 4, not to exceed 60 m.

#### *Median Barrier Delineators*

Median barrier delineators may be placed at 50 m intervals. A spacing of 30 m may be appropriate for collision prone locations on tangent sections, and where glare from opposing headlights could impair the driver's perception of the barrier.

Top median barrier delineation may be installed with angularity of 15 degrees to obtain the most reflectivity from both directions on both flat and curved sections of roadway.

## 4.4 Chevron Alignment Sign

For chevron alignment sign design details, refer to OTM Book 6 (Warning Signs).

### **Purpose and Background**

The purpose of the chevron alignment sign is to provide additional guidance to drivers at sharp changes in the horizontal alignment of the roadway. Sharp curves on rural roads or non-illuminated urban roads are often hazardous. Chevron alignment signs warn drivers of the need to be cautious in the approach to a sharp curve.

### **Sign Types**

The standard-sized chevron alignment sign (Wa-9) should be used where the posted speed is 60 km/h or less.

The oversize chevron alignment sign (Wa-109) should be used where the posted speed is 70 km/h or greater.

### **Guidelines for Use**

Where the advisory speed tab sign is used on sharp curves, sharp reverse curves or turns, chevron alignment signs must be used along the curves/turns and their approaches if:

- The location is rural in nature; or
- The location is urban in nature and is non-illuminated.

Curve delineation devices are not required in urban, illuminated areas, since roadside features such as buildings and streetlights offer drivers ample indication of changes in horizontal road alignment.

The arrow symbol on the chevron alignment sign must point in the direction of the curve.

All signs used at a given location must be the same size.

Where chevron alignment signs are used, post-mounted delineators must be omitted. Using both signs and delineators would create visual clutter and promote driver confusion.

## Location Criteria

It is important to ensure that chevron alignment signs are clearly visible to approaching drivers. Their effectiveness is dependent on their position and number.

Chevron alignment signs must be placed only on the outside of a sharp curve or turn, and positioned at right angles to oncoming traffic.

The typical placement of chevron alignment signs is so that the bottom is 1.5 m above the outside edge of the closest traffic lane. However, when vehicles are approaching on a gradient, chevron alignment signs may be placed higher or lower, so that they will be illuminated by low-beam headlights.

At least four chevron alignment signs must be used at a single location. Spacing of the chevron alignment signs is shown in Table 7, and is dependent on radius (or degree of curvature). Chevron alignment signs should be positioned to be visible for at least five seconds to an approaching driver at night.

## Special Considerations

The signs must have Type III or IV high intensity sheeting, as a minimum requirement, as of January 1, 2002. Type I sheeting is the minimum requirement prior to the date indicated.

---

## 5. Object Markings

### Purpose and Background

Objects within and immediately adjacent to the pavement constitute a hazard to passing traffic. Bridge piers and abutments, narrow structures, raised median islands, guide rail approach ends, trees, rocks, and poles are all objects that can encroach on the roadway. Object Marker signs and Object Markings warn road users that they are approaching these types of objects, so that they can adjust their path and reduce speed, if necessary, to avoid contact with them.

### 5.1 Object Marker Signs

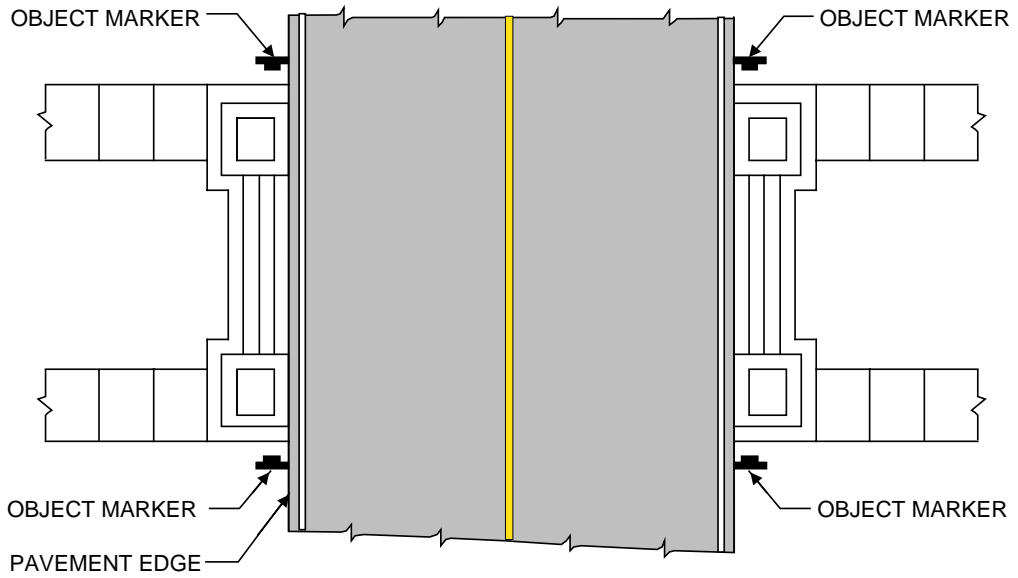
For object marker sign design details, refer to OTM Book 6 (Warning Signs).

### Sign Types

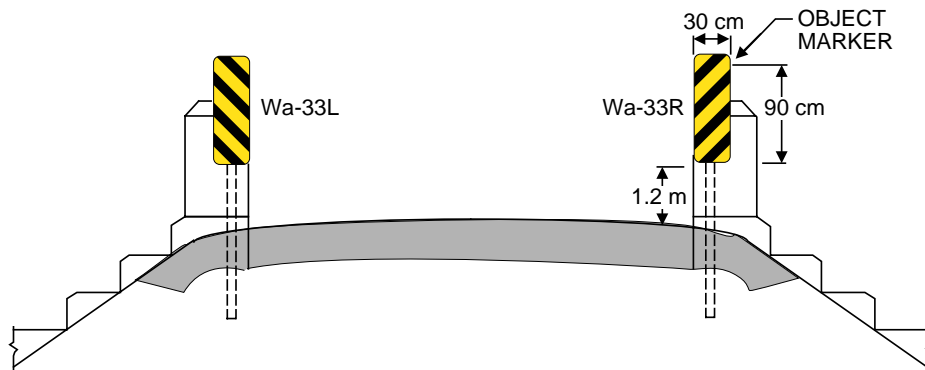
The object marker sign (One Direction) (Left Version) (Wa-33L) is placed to the left of approaching traffic, and has stripes which slope at a 45-degree angle down to the right, toward the travel lanes of the roadway.

The object marker sign (One Direction) (Right Version) (Wa-33R) is placed to the right of approaching traffic, and has stripes which slope at a 45-degree angle down to the left, toward the travel lanes of the roadway.

Figure 57 – Typical Marker Location at Bridge Ends



PLAN



CROSS SECTION

The object marker sign (Both Directions) (Wa-33LR) is placed so that approaching traffic can travel either to the left or right of the sign, and has stripes with slope at a 45-degree angle down to both the left and the right, toward the travel lanes of the roadway.

### Guidelines for Use

If a structure such as a bridge pier or abutment is on the roadway shoulder or within 2 m of the roadway edge, and is not protected by an approved safety appurtenance or guide rail system, then an object marker sign must be used to mark all of its edges. Yellow and black markings must also be painted directly onto the structures. See Subsection 5.2 of this Book for additional details on painted markings.

The object marker sign must be used on a structure wherever a narrow structure sign (Wa-24) is used in advance of the structure (More information on the narrow structure sign is provided in Section 4 of Book 6). If the structure extends above the top of the marker, yellow and black markings must be painted onto the actual structure. Figure 57 shows the typical placement of object marker signs at bridge ends. See Subsection 5.2 of this Book for additional details on painted markings.

Object marker signs may be used to mark all other hazards (such as trees, rocks, poles, curbs or guide rail approach ends) on the shoulder or within 2 m of the edge of the roadway in rural areas.

Object marker signs must mark median dividers within the flow of traffic, and raised or depressed islands.

Object markers may be installed alone or in combination with signs such as the keep right sign (Rb-25), double arrow sign (Wa-17) or guide signs. More information on the double arrow sign is provided in Book 6, Section 2 (Roadway Alignment Signs) and more information on the keep right sign is provided in Book 5 (Regulatory Signs).

Object marker signs must be used on the approach ends of channelizing islands or dividers where traffic streams diverge and do not rejoin (such as right-turn channelization or freeway ramp gores). If inadequately indicated, this type of configuration may be unexpected by drivers, causing confusion and possibly erratic manoeuvres or other errors.

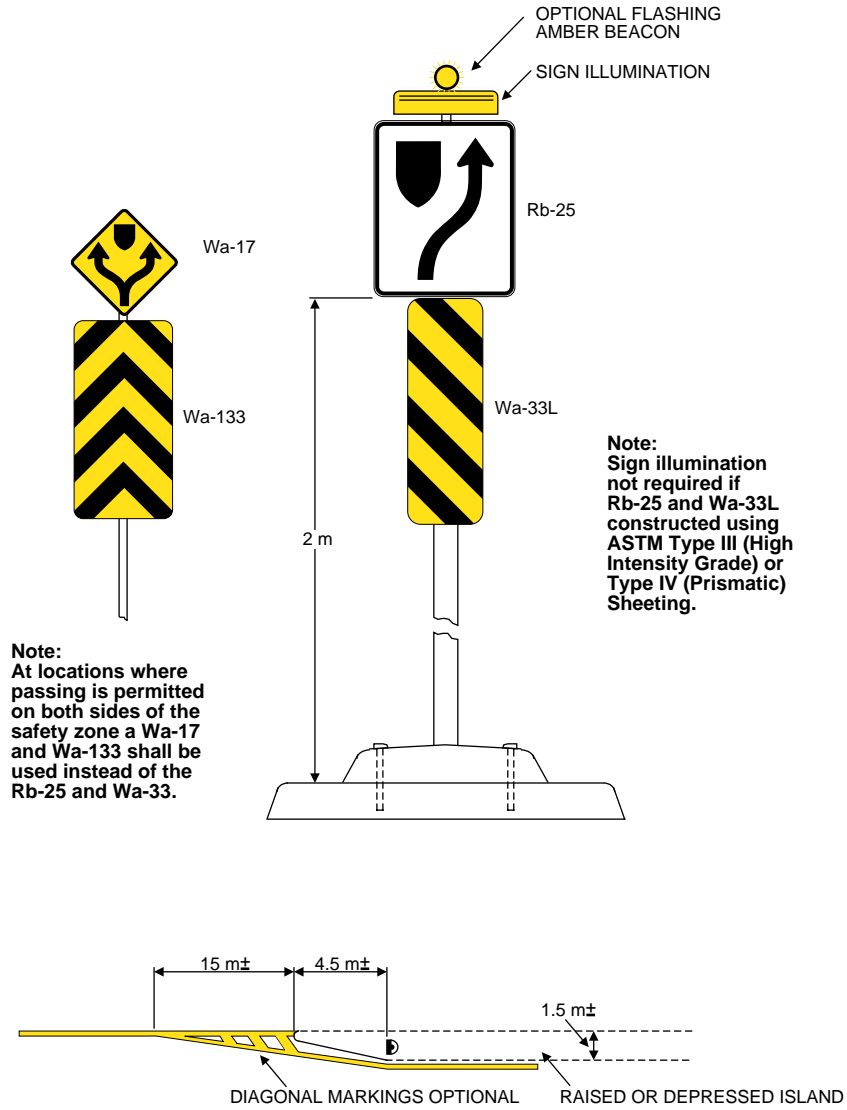
### Location Criteria

The object marker sign should normally be installed so that the bottom of the sign is 1.2 m above the surface of the nearest traffic lane.

When the object marker sign applies to a hazardous object that by its nature requires a lower or higher mounting, the vertical mounting height may vary according to the need. The vertical mounting height may also be varied to accommodate the height at which the headlights of an approaching vehicle on an uphill or downhill gradient will strike the marker.

For object marker signs mounted on structures or objects, the inside edge of the sign (edge closest to the roadway) must be in line with the inside edge of the structure or object it marks.

Figure 58 – End Protection for Raised or Depressed Safety Zone



### Winter Maintenance Considerations

Winter maintenance vehicle operators also receive beneficial guidance from object markers on hazards that are either on or adjacent to the roadway shoulder. An object marker, on or in front of the approach end treatment of a guide rail for example, assists operators in orienting themselves and avoiding damage to the device.

Where needed, object markers on guide rail should be supplemented with snowplow markers, indicating to winter maintenance vehicle operators the location of the start or end of the guide rail system. A standard for presenting this information should be adopted within the jurisdiction, and used consistently.

### Special Considerations

Object marker signs must have Type III or IV high intensity sheeting, as a minimum requirement, as of January 1, 2002. The minimum requirement prior to the date indicated is Type I sheeting.

## 5.2 Markings on Objects Adjacent to the Roadway

If a structure such as a bridge pier or abutment is on the roadway shoulder or within 2 m of the roadway edge, and is not protected by an approved safety appurtenance or guide rail system, then painted markings must be used to mark all of its edges.

Painted markings are to consist of the following:

- Alternating yellow and black stripes sloping downward at a 45 degree angle toward the roadway.
- The stripes should be at least 30 cm wide, and must be at least 10 cm in width.
- On any one structure, there must be at least four black stripes of equal width.
- The portion of the structure facing approaching traffic must be striped from a point 30 cm above the roadway to an upper point 2 m to 3 m above the roadway surface. The width of the striped area must not exceed 45 cm.
- The inside edge of the markings must be in line with the inner edge of the obstruction.

The wall parallel to the roadway must not be striped.

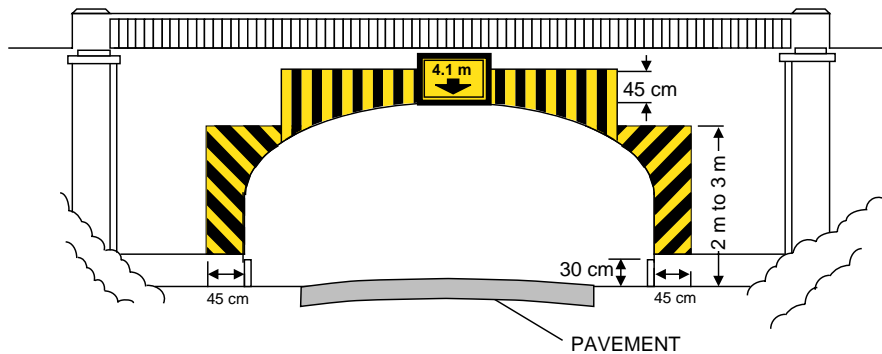
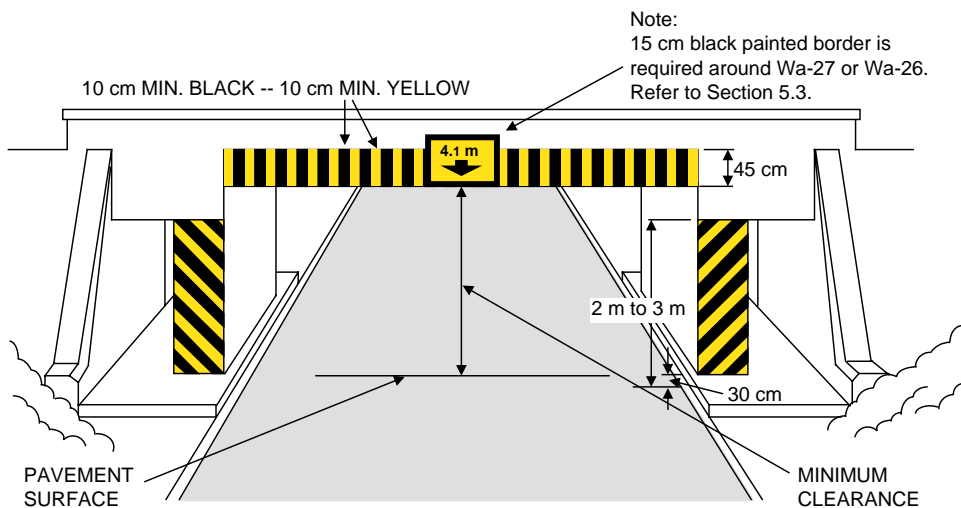
For structures with restricted overhead clearance, see Subsection 5.3 of this Book.

## 5.3 Markings on Objects Within the Roadway

At night, an unreflectorized object in the roadway may not be visible to an approaching driver using low-beam headlights until the vehicle is too close to safely avoid it. For this reason, hazardous objects within the roadway must be marked with alternating black and yellow stripes. The stripes must be at least 10 cm wide and ideally should be 30 cm wide. The stripes may be widened to provide adequate visibility, depending upon the size of the obstruction and the speed of approaching traffic. At any one location the stripes must be uniform in width.

In addition to object markings on or before the obstruction, appropriate pavement markings (described below in this section) must be applied in advance of the obstruction as an approach warning. This combination of markings will help alert the driver to the obstacle, giving sufficient time to manoeuvre the vehicle along the safest path.

Figure 59 – Clearance Markings Low Clearance Structures



**ARCH TYPE UNDERPASS**

Note:  
See Book 6 for low clearance sign criteria.

KEEP RIGHT (Rb-25) or other appropriate signs must be used in conjunction with the object markings to direct traffic around one or both sides of the obstruction as illustrated in Figure 58. (Refer to OTM Book 12 (Traffic Signals) for more information about signage.) An amber flashing beacon may be mounted directly above the sign. The intensity of the beacon should be adequate to attract approaching motorists' attention without distracting them from nearby traffic control devices or normal driving tasks.

### Safety Zones, Islands, Median Dividers

All raised or depressed islands and median dividers within the line of traffic must be marked by an object marker as illustrated in Figure 58.

Object markers may be installed alone or in combination with signs (such as KEEP RIGHT, KEEP LEFT, double arrows, or guide signs) located within an island. (Refer to OTM Book 12 (Traffic Signals) for more information about signage.) A sign directing traffic to one or both sides of an island, as appropriate, must be provided when approaching traffic has a common direction and destination.

Object markers must be used on the approach ends of channelizing islands or dividers where traffic streams diverge and do not rejoin (such as right-turn channelization or freeway ramp gores). If inadequately marked, this type of configuration can pose an expectancy violation to drivers, causing confusion and possibly erratic manoeuvres or other errors. For additional visibility, the approach end curbs of channelizing islands may be marked, using alternating black and yellow stripes at least 10 cm wide and ideally 30 cm wide. Where normal curb heights occur, the stripes must be vertical. Where marked buffers are erected on channelizing islands, their markings must slope 45 degrees downward toward the side or sides on which traffic must pass.

### Bridge Piers

The design of approaches to structures like bridge piers requires particular care to ensure that drivers are aware of the lateral limits of the roadway and have sufficient time to adjust their speed and lane position.

Bridge piers must be marked with alternate black and yellow stripes at least 10 cm wide, and ideally 30 cm wide, sloping 45 degrees downward toward the side on which traffic must pass. The stripes must be equal in width. The striping may be painted on the face of the pier and illuminated, or, if illumination is not available, may be formed of retroreflective materials applied to an independent surface that is attached to the pier.

If all approaching traffic is required to pass to the right of the pier, a KEEP RIGHT sign (RB-25) must be attached to the pier or erected on a post immediately in front of it. If the sign is attached to the pier, a 15 cm solid black border must be placed around the perimeter of the sign.

### Structures with Restricted Overhead Clearance

Overhead structures must be marked above the roadway when the clearance between the road surface and the structure is less than 4.15 m. Markings must consist of black and yellow vertical stripes at least 45 cm high, extending upward from the bottom edge of the overhead structure, and across its width from one side of the roadway to the other. The stripes must be at least 10 cm wide and ideally should be 30 cm wide. The striping may be painted on the face of the pier and illuminated, or, if illumination is not available, may be formed of retroreflective materials applied to an independent surface that is attached to the pier. Typical markings for overhead structures are illustrated in Figure 59.



The LOW CLEARANCE sign (Wa-26) must be mounted on the structure over the lane or lanes to which the sign applies. A 15 cm solid black border must be placed around the perimeter of the sign.

### Pavement Markings on Approaches to Obstructions

Drivers expect to be given advance warning of road hazards. Pavement markings must be used to guide approaching traffic away from fixed obstructions within the roadway.

For fixed obstructions such as bridge supports, refuge islands, median islands, and channelization islands, approach markings must consist of two diverging lines as shown in Figure 59 and Figures 54 through 56, to guide traffic away from the object.

If the obstruction is between opposing traffic streams, the diverging lines must be solid yellow retroreflective lines approximately 10 cm wide. They must extend from the directional dividing line to points 15 cm clear of the edges of the obstruction and 3 m further on either side parallel to it.

Where traffic moving in the same direction is permitted to pass on both sides of the obstruction, the lines must be white retroreflective lines approximately 10 cm wide. They must extend from the lane line to points 30 cm clear of the edges of the obstruction and 3 m further on either side parallel to it.

The length over which the approach lines diverge will depend on the width of the obstruction and the speed of the approaching traffic. Table 6 sets out minimum approach marking lengths for various combinations of object widths and operating speeds. For example, if the obstruction is 4 m wide, and the 85th percentile or prevailing speed is 80 km/hr, an approach marking should be at least 130 m long.

If traffic is required to pass to the right of the obstruction, diagonal markings enclosed within the diverging lines may be used as shown in Figure 59. If used, the diagonal lines must be yellow retroreflective lines 45 cm to 60 cm wide, angled at 45 degrees and spaced 6 m centre to centre. In urban areas, the spacing may be reduced from 6 m to 3 m.

If traffic may pass on both sides of an obstruction, herringbone markings (also known as “chevron markings”) enclosed within the diverging lines may be used as shown in Figure 60. If used, the lines must be white retroreflective lines 45 cm to 60 cm wide, spaced 6 m centre to centre, and applied in a herringbone pattern so that the angle points toward approaching traffic. In urban areas, the spacing may be reduced from 6 m to 3 m.

Approach markings for objects within the roadway are illustrated in Figures 58, 60, and 54 through 56.

If the directional dividing line of the approach pavement is offset from that of a divided highway as shown in Figure 54, the minimum length of the approach marking must be determined by both the median width and the offset of the centre lines, using Table 6 and the formula for determining taper lengths:

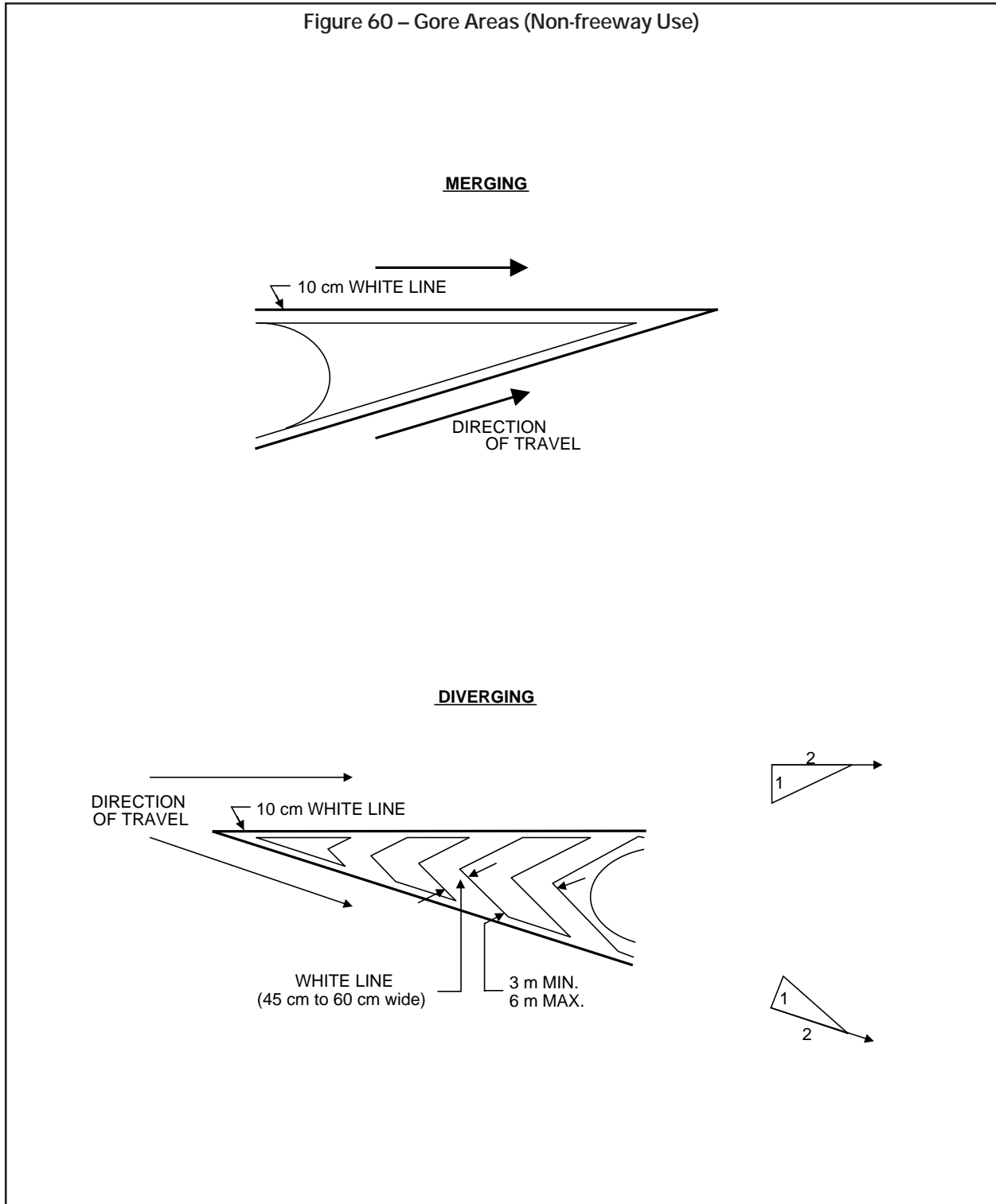
$$\text{Taper Length} = \frac{S \times W}{1.6}$$

Where: S = posted speed limit (km/hr)  
W = lane offset (m)

The following example illustrates the calculation:

In this example, the median is 2 m wide, the offset (perpendicular) distance between the two offset directional dividing lines is 3 m, and traffic operates at the speed limit of 80 km/hr. A taper length of

Figure 60 – Gore Areas (Non-freeway Use)



150 m is calculated using the preceding equation, using inputs of speed limit (80 km/hr) and lane offset (3 m). An additional minimum length of 70 m is required on the basis of Table 6, using inputs of operating speed (80 km/hr) and obstruction width (2 m). The total minimum length of the approach marking is therefore 220 m, the sum 150 m and 70 m.

### 5.4 Barricades

Barricades are portable or fixed devices with one to three marked rails. Barricades are used to control traffic by closing, restricting, or delineating all or part of a road. Their primary function is to delineate excavation or construction areas in or near the

**Table 6 – Minimum Length of Approach Markings (m) for Obstructions within the Pavement Area**

Operating Speed	Road Type	Obstruction Width (m)						
		1	2	3	4	5	6	7
30	Rural	50	50	50	50	50	70	80
	Urban	20	30	40	50	60	70	80
40	Rural	50	50	50	65	80	95	110
	Urban	25	40	50	65	80	95	110
50	Rural	50	50	65	80	100	120	135
	Urban	30	50	65	80	100	120	135
60	Rural	50	55	75	100	120	140	165
	Urban	35	55	75	100	120	140	165
70	Rural	50	65	90	115	140	165	190
	Urban	40	65	90	115	140	165	190
80	Rural	50	70	100	130	160	190	215
	Urban	45	70	100	130	160	190	215
90	Rural	50	80	115	145	180	210	245
	Urban	50	80	115	145	180	210	245
100	Rural	55	90	125	165	200	235	270
	Urban	55	90	125	165	200	235	270
110	Rural	60	100	140	180	220	260	300
	Urban	60	100	140	180	220	260	300
120	Rural	65	110	150	195	240	280	325
	Urban	65	110	150	195	240	280	325

Note: The above values are derived from  $D = (0.36W + 0.18)S$ , where D = approach distance in metres, W = width of obstruction in metres, and S = speed in kilometres per hour. (For rural conditions, distance must not be less than 50 m.)

traveled portion of the roadways, and block off all or part of the street where partial or full road closures become necessary. A description of the types of barricades and their design criteria is provided in OTM Book 7 (Temporary Conditions). Approaches to barricades should be adequately marked, as the presence of barricades may surprise motorists, especially commuters who are accustomed to a routine drive.

On divided roads with high traffic volumes, vehicular penetration into work sites can be prevented by using a “New Jersey” concrete barrier. “New Jersey” barriers should not be used to channelize traffic and their use should be determined by worksite protection requirements. Temporary pavement edge lines and reflective delineation should be used with “New Jersey” barriers.

Stripes on barricades must be alternating vertical orange and black retroreflective stripes. Normally stripes must be 150 mm wide, but on rails less than 900 mm long, they may be only 100 mm wide.

Where a barricade extends entirely across a roadway, the stripes should slope downward in the direction toward which traffic must turn. If both right and left turns are possible, the stripes may slope downward in both directions from the centre. If turns are not intended, the stripes should slope downward toward the centre of the barricade or barricades.

Barricades may include other unstriped horizontal panels necessary to provide support or stability.

The safety of vehicle occupants, pedestrians, and worksite personnel should be considered in the design and installation of barricades. In the event of an impact, the barricade should not pose an undue hazard to road users or worksite personnel.

## 5.5 Channelizing Devices

Channelizing devices are intended to alert drivers to hazards in or near the traveled way which have been created by construction or maintenance activities, and guide traffic safely past these hazards.

Channelizing devices include traffic cones, tubular markers, flexible drums, and pavement markings. Traffic cones and tubular markers are sometimes used outside construction and maintenance areas for general traffic control. They help to emphasize reversible lane delineation, channelizing lines, and islands. A description of the types of channelizing devices and their design criteria is provided in OTM Book 7 (Temporary Conditions).

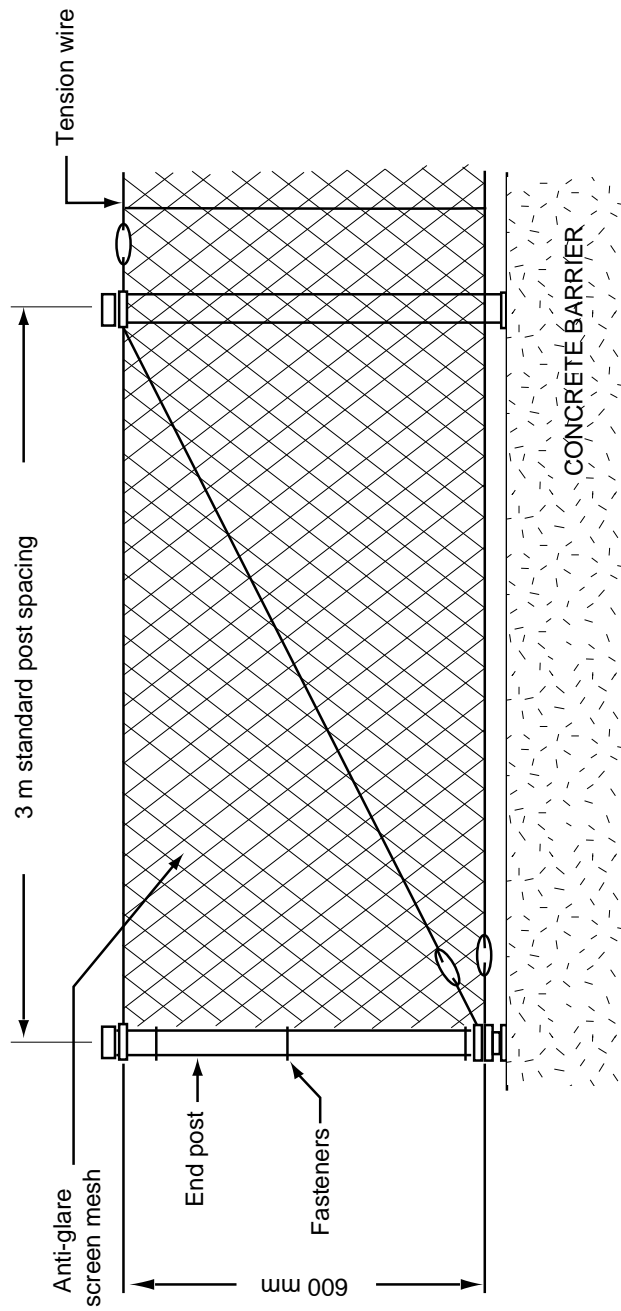
Channelizing devices used on low-speed roads during the daytime must be at least 450 mm high. On freeways and other high-speed roads, on any facility during hours of darkness, or when more conspicuous guidance is needed, their minimum height must be increased to at least 700 mm.

Channelizing devices must be made of materials that can withstand impact without damage to themselves or vehicles.

Cones and tubular markers used outside construction and maintenance areas must be the same colour as the pavement marking they supplement or for which they are substituted. They should be kept clean and bright for maximum target value. For nighttime use they must be reflectorized.

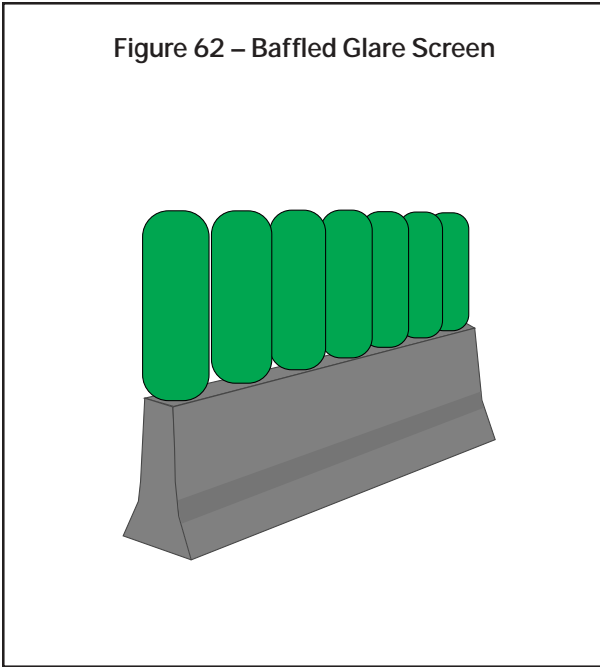
Retroreflectivity of tubular markers must be achieved using at least two 75 mm white retroreflective bands no more than 150 mm apart. The top band must be placed no more than 50 mm from the top of the device.

Figure 61 – Wire Glare Screen



Source: Ontario Roadside Safety Manual, Section 3.4.4

Figure 62 – Baffled Glare Screen



Retroreflectivity of cones must be achieved using a white retroreflective band at least 150 mm wide, 75 mm to 100 mm from the top of the cone. If the traffic cone is 700 mm wide or more, the standard 150 mm band must be supplemented with an additional 100 mm white band at least 50 mm below the 150 mm band. The retroreflective material must have a smooth sealed outer surface that will display approximately the same colour during both day and night.

## Glare Control

### 6.1 General

#### Purpose

Glare affecting drivers originates from several sources, including roadside and overhead lighting and the headlights of oncoming traffic. Glare can distract drivers and temporarily impair vision, particularly in older drivers.

On new facilities, potential glare problems should be addressed by appropriate horizontal and vertical alignment design, or by barrier selection.

On existing facilities, concrete barriers can usually block the glare from oncoming traffic. However, sometimes barriers are not high enough to reduce glare effectively. In this case, concrete barriers may be supplemented with glare screens to reduce or eliminate headlight glare.

Glare screens may also serve as delineators when enhanced by retroreflective devices. Glare screens may also be used during roadway construction and maintenance to reduce driver distraction by blocking the view of roadside activities.

Glare screens are generally not designed to reduce glare generated by roadside facilities and by headlights shining into the driver's eyes through the rearview and sideview mirrors.

## Types of Glare Control Devices

Glare control devices are available as wire screens or plastic baffles, and are generally retrofitted on existing concrete barriers.

- Wire glare screens, as shown in Figure 61, are made of wire mesh, 600 mm high, supported by posts that are fastened to the top of a concrete barrier at approximately 3 m intervals.
- Plastic baffles, as shown in Figure 62, may be installed on the top of a concrete barrier, either in tracks or in pre-assembled sections approximately 2.5 m long. The baffles are made of closely spaced molded plastic between 0.5 m and 0.9 m high, and must be capable of withstanding vehicular impact. Baffled glare screens are usually a proprietary product.

“Tall Wall” barriers can incidentally reduce glare from opposing headlights but are not normally installed as glare control devices.

## Design

Because of their placement on concrete barriers within or close to the roadway, glare screens are susceptible to vehicle impact. The screen must be designed to be flexible and withstand impacts, or to yield in a way that is not harmful to vehicle occupants, nearby pedestrians, or road workers. The glare screen should also be easily repairable.

## Installation, Maintenance, and Removal

A glare screen should require little maintenance or ongoing repair, so that expense is minimized and risk to maintenance crews and motorists is reduced.

Glare screens can diminish or restrict sight distances, particularly near curves. Before installing the glare screens, their effect on safe stopping sight distances should be considered for both directions of traffic.

## 6.2 Applications

Glare screens are beneficial on divided highways where one or more of the following factors are present:

- High volume two-way night-time traffic;
- Narrow median between lanes of opposing traffic;
- Curved in vertical alignment, particularly vertical sags;
- Superelevation or grade separation resulting in situations where vehicles traveling in one direction are higher than those traveling in the other direction.

Glare screens may also be beneficial in the presence of other factors. These include:

- Service roads immediately adjacent to highway facilities;
- Rail lines parallel to highways;
- At intersections and interchanges, where potentially confusing traffic patterns exist;
- Permanent or temporary contra-flow operations;
- Work zones, where drivers may be subjected to glare or distracting elements;
- Locations with a history of collisions attributable to glare.

---

## Index

### A

Application of Chevrons, 4.4  
 Application of Delineators, 4.3  
 Application of Glare Control Devices, 6.2  
 Application of Markings and Delineation, 2.6  
 Approach Markings For Obstructions, 3.7

### B

Barricades, 5.4  
 Barrier Lines, 3.7  
 Bicycle Lane Markings, 3.9  
 Bus Bays, 3.9

### C

Channelizing Devices, 5.5  
 Chevrons, 4.4  
 Clearance and Vehicle Guidance, 3.9  
 Coloured Pavement, 3.11  
 Colours, 2.4  
 Colours of Delineators, 4.3  
 Colours of Pavement, 3.11  
 Continuity Lines, 3.5  
 Contrast, 2.3  
 Controlled Intersections, 3.8  
 Criteria for Use of No Passing Zones, 3.7  
 Crossing Approaches, 3.9  
 Crossovers, 3.9  
 Crosswalks, 3.8, 3.9  
 Curb Markings for Delineation, 4.2  
 Curb Markings and Restrictions, 3.10

### D

Delineation, 4  
 Delineation and Driver Requirements, 2.3  
 Delineators, 4.3  
 Delineators Design, 4.1  
 Design of Glare Control Devices, 6.1  
 Devices 3.3  
 Directional Dividing Lines, 3.4  
 Disabled Requirements: Location, Width, Marking, 3.10  
 Driver Factors, 2.3

### E

Edge Lines, 3.4  
 Edge Lines for Freeways and Multi-lane Roadways, 3.4

### F

Full-time Bus/HOV Lane, 3.9  
 Functions of Markings and Delineation, 2.1

### G

Glare Control, 6  
 Glass Beads, 2.3  
 Guide Lines, 3.8

### H

Horizontal Curves, 3.7

### I

Illumination, 2.3  
 Installation, Maintenance, and Removal of Glare Control Devices, 6.1  
 Installation and Removal of Delineators, 4.1  
 Interchange Ramps and Channelization Lines, 3.6  
 Intersections, 3.8



## L

Lane Designation, 3.9  
 Lane Lines, 3.4  
 Lane Lines for Rural Roads, 3.4  
 Lane Lines for Urban Roads, 3.4  
 Lane Reductions, 3.7  
 Limitations, 2.2  
 Lines, 3.4

## M

Maintenance, 2.9  
 Maintenance of PMDs, 4.1  
 Maintenance of RPMs, 3.3  
 Marking, 3.9  
 Marking, Bridge Ends and Other Fixed Hazards, 5.2  
 Marking, Bridge Piers and Abutments, 5.2  
 Marking, Bridge Piers within the Roadway, 5.3  
 Marking, Objects Adjacent to the Roadway, 5.2  
 Marking, Objects within the Roadway, 5.3  
 Marking, Restrictions, 3.10  
 Marking, Safety Zones, Islands, Median Dividers, 5.3  
 Marking, Structures with Restricted Overhead Clearance, 5.3  
 Materials, 2.5, 3.2  
 Multi-lane Rural Roads, 3.4  
 Multi-lane Urban Roads, 3.4

## N

Narrow Bridges, 3.7  
 No-passing Zones, 3.7

## O

Object Marker Design, 5.1  
 Object Marker Mounting Height, 5.1  
 Object Markings, 5.1

## P

Paint, 3.2  
 Parking, 3.10  
 Part-time Bus/HOV Lane, 3.9  
 Passing Zones (Truck Climbing and Added Passing Lanes), 3.7  
 Pavement Markings, 3.1  
 Pavement Markings, Approaches to Obstructions, 5.3  
 Pavement Markings, Colours, 2.4  
 Pavement Markings, Function, 3.1  
 Pavement Markings, Limitations, 3.1  
 Pavement Markings, ReflectORIZATION, 3.1  
 Pavement Markings, Types, 3.1  
 Pedestrians, 3.9  
 Placement and Spacing of Chevrons, 4.4  
 Placement and Spacing of Delineators, 4.3  
 Preformed Tape, 3.2  
 Prismatic Cube-corners, 2.3  
 Purpose of Delineation, 4.1

## R

Railways, 3.9  
 Removal of Markings, 2.8  
 Reserved Facility Markings, 3.9  
 Retroreflectivity, 2.3, 4.1  
 Retroreflectometers, 2.9  
 Rumble Strips, 3.3  
 Rural Roads: Two lanes, Two Ways, 3.4

## S

School Crossings, 3.9  
 Stalls: Type, Length, Width, Setback, 3.10  
 STOP Signs, 3.8  
 Substituting for Pavement Markings, 3.3  
 Supplementing Other Markings, 3.3  
 Symbols, 3.12

## T

Temporary Conditions, 2.7  
Temporary Materials, 3.2  
Temporary RPMs (TRPMs), 3.3  
Thermoplastic, 3.2  
Traffic Calming Devices, 3.8  
Traffic Control Devices, 3.8  
Transit and High Occupancy Vehicles, 3.9  
Transition Lines, 3.5  
Transition Lines and Continuity Lines, 3.5  
TRPMs and RPMs Installation, 3.3  
Turn Lanes, 3.8  
Two-component Cold Curing, 3.2  
Two-lane Roadways, 3.4, 3.7  
Two-lane Rural Roads, 3.4  
Two-lane, Two-way Urban Roads, 3.4  
Types of Glare Control Devices, 6.1

## U

Urban Roads: Multi-lane Roads, 3.4

## V

Vertical Curves, 3.7

## W

Word Messages, 3.12  
Words and Symbols, 3.12



---

## Appendix A • Definitions

### A

#### **AADT**

Abbreviation for Average Annual Daily Traffic.

#### **AASHTO**

American Association of State Highway and Transportation Officials.

#### **Abrasion**

A condition manifested in pavement markings by gradual surface erosion, thinning, and disappearance of the film due to wind, water, sand, and vehicle tire wear.

#### **AC**

Abbreviation for asphaltic concrete, or alternating current, depending on context.

#### **Acceleration Lane**

A speed change lane for the purpose of:

- (1) enabling a vehicle entering a roadway to increase its speed to a rate at which it can more safely merge with through traffic;
- (2) providing the necessary merging distance; and
- (3) giving the main road traffic the necessary time to make appropriate adjustments.

#### **ADT**

Abbreviation for Average Daily Traffic.

#### **Advisory Speed**

The speed, determined to the nearest 5 km/h, at which traffic may safely negotiate a potential hazard under favourable driving conditions.

#### **Approach Speed**

The maximum safe speed that can be maintained over a short section of highway immediately in advance of a potentially hazardous location, taking into account pavement and shoulder width, horizontal and vertical alignment, sight distance, and other controlling factors. The approach speed does not necessarily coincide with the design speed.

#### **ASTM**

American Society for Testing and Materials.

#### **At-grade Intersection**

An intersection of two roadways where there is no vertical separation between the two roadways at their point of intersection.

#### **ATSSA**

American Traffic Safety Services Association.

#### **Average Daily Traffic (ADT)**

The total volume during a given time period in whole days greater than one day and less than one year divided by the number of days in that time period.

### B

#### **Ball Bank Indicator**

A mechanical or electronic device that can be mounted inside a four-wheel vehicle; readings of the ball bank indicator show the combined effects of the body rolling angle, centrifugal force and superelevation angle to estimate the safe operating speed around a curve.

**Barrier**

A device which provides a physical limitation, through which a vehicle would not normally pass, and is intended to contain or redirect an errant vehicle of a particular size range, at a given speed and angle of impact.

**Bond**

Adhesive quality of a coating to a Substrate.

**Brightness**

A term that refers to human perception of Luminance. Whereas luminance is a photometrically measured quantity, brightness describes how intense a light source or lighted surface appears to the human eye.

**Broken Line**

A Pavement Marking consisting of a cycle of marking segments and gaps. Broken lines are permissive and inform drivers that they are permitted to cross a broken line, (two-lane, two-way highways) or that there is a change in use of a particular lane (continuity lines).

**BTU**

Abbreviation for British thermal unit.

**C****Centreline**

See Directional Dividing Line.

**Channelization**

The separation or regulation of traffic movements into definite paths of travel by use of pavement markings, raised islands, or other suitable means to facilitate the safe and orderly movement of traffic, both vehicular and pedestrian.

**Chevron Alignment Sign**

A delineation sign used to delineate sharp roadway alignment changes.

**Construction and Maintenance Signs**

A group of Regulatory and Warning Signs used for the protection of public traffic and workers in the vicinity of a work area located on or near the roadway. See Book 7.

**Continuity Line**

A lane line of reduced spacing and increased width, designed to alert road users to an impending change in lane function. See also Wide Line.

**Continuous Wide Median**

On a divided highway, a median that has a continuous width of 10 m or more. See also Divided Highway.

**Controlled Access Highway**

A major highway along which the right of access to abutting property is controlled by the Department of Highways.

**Controlled Intersection**

An intersection where traffic approaching from any or all directions is regulated by some form of traffic control device.

**Cost Effectiveness**

The relationship between a measure's benefit over its service life and the total costs it incurs over its service life, often expressed as a ratio.

**Crossover**

See Pedestrian Crossover.

**Crosswalk**

See Pedestrian Crosswalk.

**Curb Marking**

A marking used to delineate the location of a curb.

**Curve Sign**

A Warning Sign used to inform drivers of an upcoming change in roadway alignment. In some cases, a reduction in speed is recommended.

**D**

**Deceleration Lane**

A speed change lane for the purpose of enabling a vehicle that is to make an exit from a roadway to slow to the safe speed on the exit after it has left the main stream of traffic.

**Delineation**

One, or a combination of several types of devices (excluding Guide Signs) that regulate, warn, or provide tracking information and guidance to drivers.

**Delineation Technique**

Refers to methods chosen to accomplish effective delineation. Selection of an appropriate marking material and method of application are part of a delineation technique.

**Delineation Treatment**

Refers to the higher-level decision process of designing delineation to be installed. Such issues as use of raised pavement markers and post markers are part of delineation treatment.

**Delineators**

Small, Retroreflective devices erected in a series adjacent to the edge of a traveled portion of the roadway for the purpose of providing positive driver guidance.

**Directional Dividing Line**

A yellow Pavement Marking indicating the division of the roadway between traffic traveling in opposite directions.

**Directional Guide Sign**

A broad class of signs providing route-finding or operational guidance to road users, including direction to specific destinations.

**Divided Highway**

A multi-lane highway consisting of roadways for opposing traffic which are separated by an unpaved area or other physical barrier, including a curbed island. See also Continuous Wide Median.

**DOT**

U.S. Department of Transportation.

**Double Line**

A Pavement Marking used on two-way, undivided roadways to inform the driver of a “no-passing” zone in both directions of travel.

**E**

**E**

Abbreviation for rate of superelevation.

**Edge Line**

A painted line marking the edge of the roadway.

**EPA**

U.S. Environment Protection Agency.

**ETP**

Abbreviation for epoxy thermoplastic paint.

**Expressway**

A divided arterial highway for through traffic with full or partial control of access and generally with grade separations at major intersections.

**F**

**F**

Abbreviation for coefficient of friction.

**FHWA**

U.S. Federal Highway Administration.

**Freeway**

An expressway with full control of access and interchanges in place of At-grade Intersections. This term includes toll highways built to a freeway configuration.

**G**

**Glass Beads**

Spheres used in conjunction with traffic paint to produce retroreflectivity in pavement markings.

**Grade Separation**

The vertical separation of two or more intersecting roadways or a roadway and another transportation mode, e.g., railroad, thus permitting traffic on all roads to cross traffic on all other roads without interference.

**Guide Sign**

A Traffic Sign used to direct traffic along a route towards a destination.

**Guideline**

A recommended (but usually not required) practice, method or value for a specific design feature or operating practice.

**H**

**Hazard Marker**

See Object Marker.

**Highway**

A general term denoting a public way for purposes of vehicular and pedestrian travel, including the entire area within the right-of-way. This includes King's Highways, regional and county roads, rural roads, municipal roads and streets.

**Highway Delineator**

One of a series of short posts with reflective heads or chevrons used to indicate horizontal alignment.

**I**

**Illuminance**

Luminous flux incident per unit of area (direct light).

**Interchange**

A system of interconnecting roadways in conjunction with one or more grade separations, providing for the interchange of traffic between two or more roadways on different levels.

**Interdictory Symbol**

An annular (circular) red band with a diagonal red stroke at 45 degrees, or as close to 45 degrees as practical, signifying that whatever is depicted within the symbol is prohibited.

**Intersection**

The area embraced by the prolongation of lateral curb lines or, if none, of the rights-of-way of two or more highways that join one another at an angle, whether or not one highway crosses the other.

**Intersection Leg**

That part of any one of the roadways radiating from the intersection which is close to the intersection but outside the area of the intersection proper.

**Intersection Sight Distance**

The distance at which a driver on the roadway approaching an intersection can see vehicles on the other intersection legs to the left and right of his or her path of travel. May also be referred to as Vision Triangle.

**K**

**King's Highway**

A highway, including secondary and tertiary roads designated under the Public Transportation and Highway Improvement Act.

**L**

**L**

Abbreviation for length.

**Lane Designation Sign**

An overhead or ground-mounted sign, erected at or in advance of an intersection, or over a lane or lanes, to regulate traffic on an approach by assigning certain traffic movements to specific lanes or a reserved lane. These signs should not be confused with Turn Control Signs.

**Lane Line**

A pavement marking, other than a directional dividing line, which separates two traffic lanes assigned to traffic moving in the same direction.

**Lane Use Sign**

See Lane Designation Sign.

**Large Arrow Sign**

A Warning Sign intended to inform drivers of a sharp change in roadway alignment.

**Left-turn Lane**

A lane reserved for left-turning vehicles and so designated by pavement markings and/or lane-use signs.

**Luminance**

The luminous flux in a light ray, emanating from a surface or falling on a surface, in a given direction, per unit of projected area of the surface as viewed from that direction, per unit of solid angle (reflective light).

**M**

**Major Road**

The principal route of two roads at an intersection. Also called Main Road.

**Marker**

See Object Marker and Route Marker.

**Median Strip**

An expanse of hard surface material separating opposing lanes on a highway. The hard surface is flush or nearly flush with the adjacent lanes.

**Multi-lane Highway**

A roadway with two or more traveled lanes carrying traffic in each direction.

**MUTCD**

Manual of Uniform Traffic Control Devices for Ontario.

**MUTCDC**

Manual of Uniform Traffic Control Devices for Canada.



## N

### NCHRP

National Cooperative Highway Research Program.

### Numbered Highway

A highway to which a number has been allotted for the purpose of identification throughout its entire length.

## O

### Object Marker

A traffic sign mounted temporarily or permanently on an obstruction, within or adjacent to the roadway, to make the obstruction as highly visible as possible.

### Off Ramp

That part of an interchange connecting a Deceleration Lane to a crossroad.

### Older Driver

A driver aged 55 years or older.

### On Ramp

That part of an interchange connecting a crossroad to an Acceleration Lane leading onto a Major Road.

### Overhead Sign

A Traffic Sign mounted above the Roadway, usually with 4.5 m to 5.3 m of vertical clearance and preferably located over the lane or lanes to which the sign applies.

### Oversize Sign

A Traffic Sign with greater proportional dimensions than the minimum dimensions specified in this Manual. Such signs are generally required on higher speed highways, or on other highways in special cases.

## P

### Paint

See Traffic Paint.

### Parking and Stopping Signs

A Traffic Sign of the regulatory type which informs drivers of the parking and stopping regulations in effect on facilities where such signs are erected.

### Parking Space Marking

Markings intended to inform drivers where they are permitted to park.

### Pavement

That part of the roadway having a constructed hard surface for the facilitation of vehicular movement.

### Pavement Marking

A coloured marking applied to the pavement to provide drivers with roadway alignment information.

### Pedestrian Crossover

Any portion of a Roadway, designated by by-law of a municipality, at an intersection or elsewhere, distinctly indicated for pedestrian crossing by signs on the highway and lines or other markings on the surface of the roadway as prescribed by the regulation and the HTA, with associated signs Ra-4, Ra-4t, Ra-10 and Ra-11.

### Pedestrian Crosswalk

Any portion of the Roadway, at an intersection or elsewhere, distinctly indicated for pedestrian crossing by appropriate pavement markings and/or signs, or by the projections of the lateral lines of the sidewalk on opposite sides of the road.

### Permissive

Refers to areas where a driver is permitted to travel.

**Post-mounted Delineator**

A delineation device that consists of Retroreflective Material mounted on a 1.2 m post to provide long-range information on roadway alignment.

**Posted Speed Zone**

A section of highway upon which the maximum speed is indicated by appropriate Regulatory Signs.

**Provincial Highway**

Any public highway under the jurisdiction of the Ministry of Transportation of Ontario (MTO). See King's Highway.

**R****Raised Pavement Marker**

A ceramic, metal, glass or plastic marking device placed on the roadway to substitute for or act as a supplement to standard pavement markings. Raised pavement markers are comprised of a variety of configurations including retroreflective and non-retroreflective markers, and markers that employ prismatic retroreflection and those that employ spherical retroreflection.

**Reflectivity**

A measure of the degree to which a surface reflects incident light. A related term, reflectance, is the amount of light reflected back from a sign, relative to the amount of light shining on the sign. See Retroreflectivity, Coefficient of (R).

**Reflectorization**

A method of incorporating light-reflective material on the approach face of a Traffic Sign so that the face will reflect light during the hours of darkness while retaining the same colours as by day.

**Regulatory Sign**

A Traffic Sign advising drivers of action they should or must do (or not do), under a given set of circumstances. Disregard of a regulatory sign would usually constitute an offence.

**Restrictive**

Refers to areas where, or times when, a driver is not permitted to travel.

**Retroreflective Material**

A type of material applied in either strips or sheets which reflects illumination back to its source.

**Retroreflectivity, Coefficient of (R)**

R indicates the proportion of light reflected back to the driver from a retroreflective sign surface, in candelas per lux per square metre. See Book 1b (Sign Design Principles), Section 9.1.

**Roadway**

The part of the highway that is improved, designed or ordinarily used for vehicular traffic, but does not include the shoulder, and, where a highway includes two or more separate roadways, the term "roadway" refers to any one roadway separately and not to all of the roadways collectively.

**Route Marker**

A Guide Sign bearing a route number which is erected along numbered highways.

**RPM**

Abbreviation for Raised Pavement Marker.

**Rural Area**

An area outside of the limits of any incorporated or unincorporated city, town, village, or any other designated residential or commercial area.

## S

### S

Abbreviation for spacing of delineators on curves.

#### Safe Speed

See Advisory Speed.

#### Safe Stopping Distance

The distance required to bring a vehicle completely and safely to rest with normal braking and road conditions.

#### School and Pedestrian Signs

A group of signs, both Regulatory and Warning, used to control vehicles and protect pedestrians wherever students and pedestrians are likely to be present and conflict with vehicles may occur.

#### School Zone

A roadway section with a mandatory 40 km/h maximum speed zone in effect every school day at designated times, in the vicinity of a school. The HTA also makes provision for 60 km/h speed zones on King's Highways.

#### Service Life (Pavement Marking)

The time required for a pavement marking to become ineffective due to its having lost its luster, lost its retroreflectivity, or having been worn completely from the pavement.

#### Shoulder

The portion of a highway between the outer edge of the roadway and the curb, or point of intersection of the slope lines at the outer edge of the roadway and the fill, ditch, or median slope, for the accommodation of stopped vehicles, for emergency use, and for lateral support.

#### Sidewalk

That portion of a road, adjacent to the traveled roadway, which has been improved for the use of pedestrians.

#### Sign Assembly

Any Traffic Sign mounted and erected alone or in conjunction with any combination of associated Tab Signs.

#### Sign Sheeting

The Retroreflective Material used on the surface of a Sign to provide good daytime and nighttime visibility.

#### Solid Line

A continuous Pavement Marking. Solid lines are restrictive; drivers are being informed that they are not to cross a solid line.

#### Speed Change Lane

A tapered auxiliary traffic lane used by traffic entering or leaving a freeway or expressway for the purpose of acceleration or deceleration respectively.

#### Speed Limit

The maximum vehicular speed allowed within any given posted or Unposted Speed Zone.

#### Statutory Speed Limit

A maximum speed limit automatically in effect on all roads, unless otherwise signed. The statutory speed limit applies even where no maximum speed limits are signed.

#### Stop Bar

A Pavement Marking placed laterally across the approach half of a traveled roadway at the site of a STOP sign, Traffic Signal, or Pedestrian Crosswalk. The line indicates the point beyond which the foremost part of a vehicle must not protrude, should the vehicle be required to stop. Also called Stop Line.

**Stop Line**

See Stop Bar.

**Striper**

A self-contained marking system mounted on a truck chassis and used to apply Pavement Markings on the road.

**Substrate**

The surface to which the sign sheeting is applied.

**Suburban Area**

An area, primarily residential, generally located between an urban centre of a community and the surrounding rural area.

**Surface**

The top of the pavement material, Substrate, or Sign Sheeting.

**Symbol Marking**

A Pavement Marking used in a specific location to guide, warn, regulate, or inform drivers where standard pavement markings are not sufficient.

**T**

**Tab Sign**

A sign smaller than the primary sign with which it is associated, and mounted below it. There are two types of tab signs:

- (1) Supplementary Tab Sign – contains additional, related information;
- (2) Educational Tab Sign – conveys the meaning of symbols during their introductory period.

**Temporary Conditions**

Roadway and traffic control conditions related to non-permanent construction, maintenance and utility work on any highway open to the public.

**Temporary Pavement Marking**

A Pavement Marking intended to be used for Temporary Conditions.

**Thermoplastic**

A class of pavement marking material whose main component is a plastic material that becomes pliable or liquid at high temperatures.

**Through Roadway**

- (1) The portion of the roadway used by through traffic as opposed to the parts used by traffic which is stopping or turning; or
- (2) A road at which vehicular traffic from intersecting roads is required to stop before crossing or entering.

**Through Traffic**

- (1) Traffic using a through roadway; or
- (2) Traffic proceeding through an area and not having an origin and destination therein.

**Traffic Control Device**

Any sign, signal, marking, or device placed upon, over or adjacent to a roadway by a public authority or official having jurisdiction, for the purpose of regulating, warning, guiding or informing road users.

**Traffic Control Signal (Traffic Signal)**

Any power-operated Traffic Control Device, whether manually, electrically or mechanically operated, by which traffic is alternately directed to stop and permitted to proceed. Traffic Signal:

- (1) When used in general discussion, a traffic signal is a complete installation including signal heads, wiring, controller, poles and other appurtenances.
- (2) When used specifically, the term refers to the signal head which conveys a message to the observer.
- (3) That part of a traffic control signal system that consists of one set of no less than three coloured lenses, red, amber and green, mounted on a frame and commonly referred to as a signal head.

**Traffic Island**

A raised or painted island designed to separate streams of vehicular traffic.

**Traffic Paint**

A pavement marking material that consists mainly of a binder and a solvent. The material is kept in liquid form by the solvent, which evaporates upon application to the pavement, leaving the binder to form a hard film.

Traffic paints are classified by, among other things, drying time:

- (1) instant dry – less than 30 seconds no track time;
- (2) quick dry – 30 to 120 seconds no track time;
- (3) fast dry – 2 to 7 minutes no track time;
- (4) conventional – over 7 minutes no track time.

See also Water-based Paint.

**Traffic Sign**

A device (other than Delineators and Traffic Control Signals) which may be erected beside or above a roadway for the purpose of regulating, warning or guiding traffic.

**Traveled Roadway**

See Roadway.

**Turn Control Sign**

A Traffic Sign, generally erected at an intersection, indicating by arrows and an Interdictory Symbol the movement or movements traffic on that approach must not take. These signs should not be confused with Lane Designation Signs.

**Turn Lane**

A lane designed to facilitate vehicular turn movements from the through roadway.

**Turn Sign**

A Warning Sign used to inform drivers of an upcoming change in roadway alignment. See also Curve Sign.

**Two-lane Highway**

An undivided two-way facility having one lane for traffic moving in each direction.

**Two-way Left-turn Lane**

The centre lane on some three, five or seven lane sections of undivided highway which is designed to facilitate left turns from each direction.

## U

### **Unposted Speed Zone**

A section of highway upon which maximum speed signs are not erected and where a Statutory Speed Limit is in effect.

### **Urban Area**

An indefinite area of land used primarily for residential, commercial, and/or industrial purposes, usually associated with a given area size, population, and density.

## V

### **v**

Abbreviation for velocity.

### **Vision Triangle**

See Intersection Sight Distance.

### **VOC**

Abbreviation for volatile organic compound.

## W

### **Warning Sign**

A sign which indicates conditions on or adjacent to a highway or street that are actually or potentially hazardous to traffic operations.

### **Water-based Paint**

A Traffic Paint that employs water as a solvent, thus nullifying the environmental concerns with many traffic paints. Also referred to as latex. See also Traffic Paint.

### **Wide Line**

A pavement marking line wider than the standard 10 cm width, typically 20 cm, up to 30 cm, in width. See also Continuity Line.



---

## Appendix B • References

### Referenced Documents

*Manual of Geometric Design Standards for Canadian Roads*; Transportation Association of Canada, 1998

*Ontario Traffic Manual; Books 1, 4, 5, 6, 7, 8, 12*; 1998

U.S. Federal Highways Administration (FHWA); *Roadway Delineation Practices Handbook*, 1994

*Section U.D. 18 Urban Supplement to the Geometric Design Guide for Canadian Roads*; Transportation Association of Canada, 1995

### Additional References

American Society for Testing and Materials (ASTM)

Canadian General Standards Board (CGSB)

*Canadian Guide to Neighbourhood Traffic Calming*; Transportation Association of Canada, 1998

Highway Traffic Act (HTA); Office Consolidation; Revised Statutes of Ontario, 1990

Section 182 of the Highway Traffic Act (R.S.O. 1990)

*King's Highway Guide Signing Policy Manual*; Ministry of Transportation Ontario, 1990

*Manual of Uniform Traffic Control Devices (MUTCD)*; Ministry of Transportation Ontario, 1985

*Tourism-Oriented Direction Signing Policy*; Ministry of Transportation Ontario, 1995



